

contents

CANON AE-1 PROGRAM

- Section 1 — Specifications and Operation** 3
- Section 2 — Removing the Cover Plates** 4
 - Predisassembly Tests 4
 - Disassembly Steps 5
 - Reassembly, Top Cover 7
- Section 3 — Adjustments and Tests, Wind Mechanism** 8
 - Operation 8
 - Curtain-travel Time, Adjustment 9
 - MG2 and MG3, Test Procedures 9
 - Second-curtain Latch, Adjustment 10
 - Wind Sequence, Test 10
 - SW5, Adjustment 10
 - Connecting-lever Arm, Adjustment 11

- Section 4 — Circuit** 11
 - General 11
 - Switch Locations and Functions 13
 - Circuit Power 14
 - Constant Voltages 14
 - Clock Signal 15
 - Light Measurement 15
 - A-D Converter 16
 - Aperture Control 17
 - Shutter-speed Control 17
 - Sound-drive Circuit 19
- Section 5 — Removing the Mirror Assembly** 20
- Section 6 — Operation of the Mirror Assembly** 24
- Section 7 — Adjustments in the Mirror Assembly** 27
- Section 8 — Disassembly of the Mirror Housing** 27
- Section 9 — Removing the Flex Circuit** 32
- Section 10 — Removing the Shutter Assembly** 34
- Section 11 — Shutter Operation** 39
- Section 12 — Exposure Adjustments** 40
- Section 13 — Adjustments Not Normally Required** 42
 - Auto Aperture 42
 - Oscillator Frequency 44
 - Offset 44
 - Maximum-aperture Correction Pin 44
 - Film-speed Wiper 46
- Section 14 — Troubleshooting Guide** 47
- Section 15 — Testing the IC's** 50
- Section 16 — Replacing the IC's** 54
- Section 17 — Supplements** 56
 - Wiring, flex circuit 56
 - Component Identification, flex circuit 57
 - Wiring, LED display board 58
 - Pin Voltages, IC1 59
 - Pin Voltages, IC2 60
 - Pin Voltages, IC3 61
 - Pin Voltages, IC4 61



Figure 1

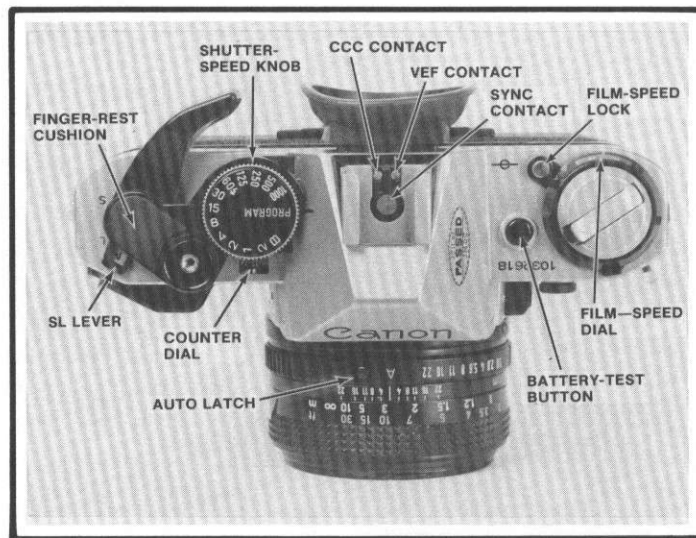

Figure 2

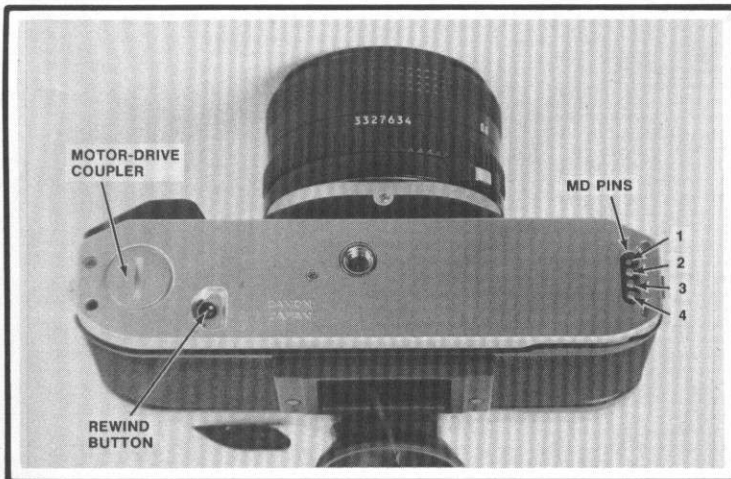

Figure 3

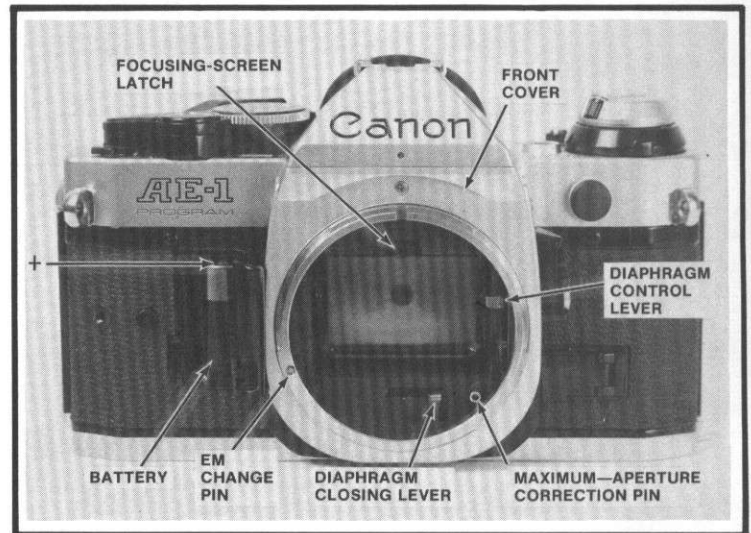

Figure 4

CANON AE-1 PROGRAM

SECTION 1 — SPECIFICATIONS AND OPERATION

- **TYPE:** Electronically controlled 35mm SLR with choice of three operation modes—program (automatic shutter speed and diaphragm opening), shutter-speed preferred, and manual. To set the program mode, turn the diaphragm-setting ring to auto and set the speed knob to program. The “P” LED in the finder should turn on when you depress the release button part way. At ASA 100, the programmed mode goes from EV1 (f/1.4, 1 second) to EV18 (F/16, 1/1000). For shutter-speed preferred, leave the lens at auto and select the desired shutter speed on the speed knob. For manual, turn the diaphragm-setting ring to a manual f/stop setting. The “M” LED in the finder should turn on when you push the release button part way.
- **METER:** Full-aperture, center-weighted metering with LED readout. The LED display indicates the aperture the camera will automatically set at the program and shutter-speed-preferred modes. In the manual mode, the LED display indicates the proper aperture for the light conditions. Turn on the LED display by pushing the release button part way or by pushing in the preview button. In the program mode, the “P” LED flickers if the camera must program a shutter speed of 1/30 or slower. The “16” LED flickers for overexposure indication, and the LED for the maximum aperture flickers for underexposure indication. At the shutter-speed-preferred mode, the “1” or “1.4” LED flickers if the camera can't set a large enough aperture for the shutter-speed setting and light conditions. The LED brightness changes with the brightness of the field of view.
- **MEMORY HOLD:** The AE lock button locks the exposure information in memory for unusual lighting conditions. Take a reading from the subject by pushing the release button part way; then depress the AE lock button. The exposure information remains in memory for as long as you keep the release button partially depressed—it's not necessary to hold in the AE lock button. The information is cleared from memory when you make an exposure or let up the release button.
- **SHUTTER:** Vertically traveling, electronically controlled focal-plane shutter. The second-curtain magnet holds the second curtain for the length of the exposure time. Since the shutter uses a digital timing circuit, the slowest speed is 2 seconds—even with the lens covered at the program mode. Curtain-travel time: 10.5ms (34mm distance), 9.9ms (32mm distance).
- **BATTERY:** One 6-volt PX28 or 544 (negative ground). To test the battery, push the battery-test button. If the battery is good, the piezo beeper will beep. The frequency of the beeper indicates the battery condition; the frequency decreases as the battery voltage drops. With 4.8V or more applied to the battery terminals, the beeper frequency is 6.5 Hz. The frequency decreases as the applied voltage decreases, reaching 1 Hz with 3.5V applied. The piezo does not beep when the battery voltage drops too low for proper operation (3.3V or lower). To replace the battery, first remove the palm grip at the front of the camera. Then disengage the latch to open the battery compartment.
- **SELF-TIMER:** Electronic self-timer providing a delay of 10 seconds. Set the self-timer by moving the SL (self, lock) lever to the “S” position. Push the release button to release the self-timer. During the self-timer delay, the piezo beeps at a frequency of 2 Hz for the first 8 seconds and 8 Hz for the final 2 seconds.
- **FLASH SYNCHRONIZATION:** X-sync only, flashcord terminal and hot shoe. The Canon dedicated-flash units automatically set the aperture and the flash speed. Regardless of the speed-knob setting (except at bulb), the shutter speed switches to 1/60. When the flash unit charges, the lightning-flash LED at the bottom of the finder display turns on; the f/stop LED simultaneously shows the f/stop which the flash unit will set. With the 188A flash unit, the LED display also shows proper flash exposure after you release the shutter. If the flash was able to supply the proper amount of light, the lightning-flash LED blinks for two seconds after the exposure.

- **LENS:** Accepts all Canon breechlock lenses. To remove the new-style lens, push the lens-release button and rotate the lens in a counterclockwise direction, Fig. 1. At the auto setting, a pin at the back of the lens pushes in the EM change pin in the lens mount. The diaphragm-control lever at the side of the lens mount then determines how far the diaphragm can close. The lens sets the maximum-aperture information by pushing in the maximum-aperture correction pin at the bottom of the lens mount. Flange-focal distance (back focus): 42.14mm (front of lens mount to pressure-plate rails), 41.9mm (lens mount to film-guide rails). Tolerance: ± 0.02 mm. Adjust by shimming the lens-mounting ring.
- **FILM-SPEED SETTING:** ASA 12—ASA 3200. To change the film-speed setting, first depress the lock button on the top cover.
- **DEPTH-OF-FIELD PREVIEW:** Cock the shutter and set a manual f/stop. Then push the stop-down lever toward the lens to close the diaphragm. The stop-down lever latches in the stopped-down position. Release the stop-down lever by pushing in the latch

button (next to the stop-down lever, visible in the stopped-down position). After using the stop-down feature, you must reset the auto-control mechanism if you want to use the program mode or the shutter-speed-preferred mode. First rotate the diaphragm-setting ring to the maximum-aperture setting. Then set the diaphragm-setting ring to auto.

- **FOCUSING SCREEN:** Accepts interchangeable focusing screens. To remove the focusing screen, push up the latch at the top of the lens mount, Fig. 4. The standard screen is the E Type (split image and microprism). Other types available: A Type (microprism only), B Type (split-image only), C Type (all matte), D Type (matte with section lines), H Type (matte with scale), I Type (double crosshair reticle), and L Type (cross split image).

- **TYPICAL CURRENT DRAW** (6V supplied to battery terminals):
 - LEDs on — 29ma
 - Shutter open — 35ma
 - Battery test — 68ma
 - Self-timer — 30ma

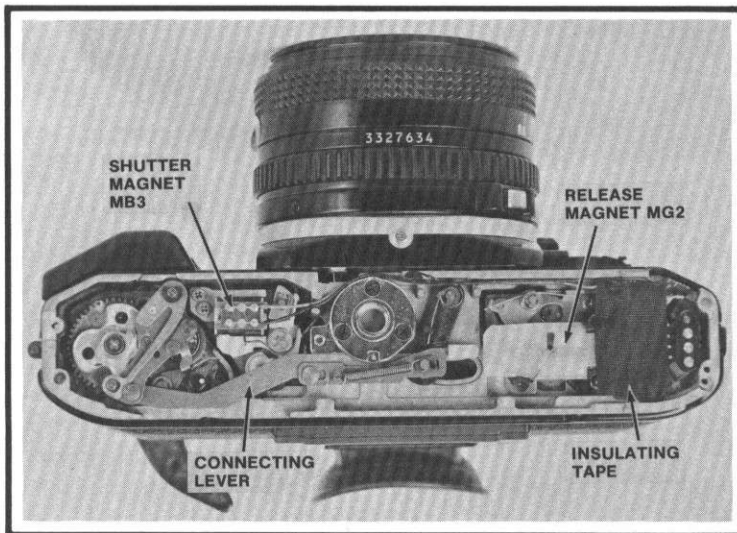

Figure 5

SECTION 2 — REMOVING THE COVER PLATES

Predisassembly Tests:

1. Dedicated flash. Check by connecting a 4.7K resistor between ground and the CCC hot-shoe contact, Fig. 2. When you push the release button part way, the lightning-flash and f/4 LEDs should turn on. The camera should deliver the flash speed of 1/60 regardless of the speed-knob setting (except at bulb). If not, suspect a defective IC2 or poor solder connections to the CCC contact.

- Maximum-aperture resistor. Watch the f/stop LEDs as you push in the maximum-aperture correction pin, Fig. 4. The f/stop indication should step down smoothly to larger f/stops as the maximum-aperture correction pin moves in. If not, suspect a dirty maximum-aperture resistor or a defective IC4.
- Power winder. You can check for proper power-winder and motor-drive switching by making ohmmeter and shorting tests at the MD pins, Fig. 3. Pin 3 should always connect to the ground. Pin 2 should connect to ground with the shutter released (no continuity to ground with the shutter cocked). Pin 4 should connect to ground when you fully depress the release button. Shorting pin 1 to ground should turn on the LED display.

Disassembly Steps:

- Remove the bottom-cover screws (3 in chrome models, 2 in black models) and lift off the bottom cover.
- Remove the lens. Take out the 4 screws holding the front cover. Lift the wind side of the front cover first to clear the preview and AE-lock switches, Fig. 6. On reassembly, seat the rewind side of the front cover first.
- Remove the 6 top-cover screws.
- Wedge the rewind shaft and unscrew the rewind knob.
- Set ASA 100. Remove the film-speed dial by taking off its snap ring, Fig. 7. Note that the film-speed dial is in two sections with a wave washer between the dial and the dial cover. Be careful to avoid turning the film-speed wiper, Fig. 8. You can then note the position of the film-speed wiper at ASA 100, the setting for exposure adjustments.
- Lift out the ASA coupler, Fig. 8.
- Remove the cemented finger-rest cushion above the wind lever.

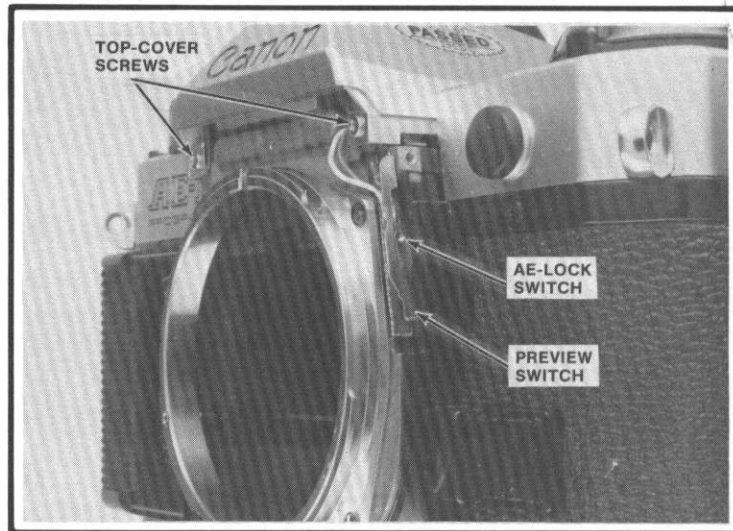

Figure 6

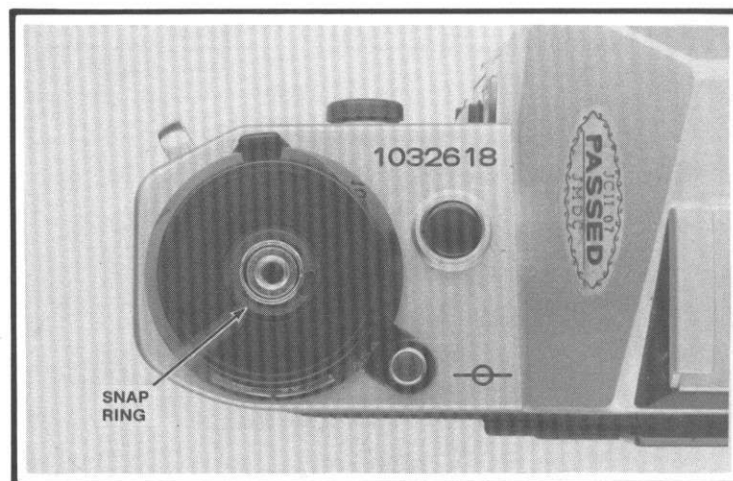

Figure 7

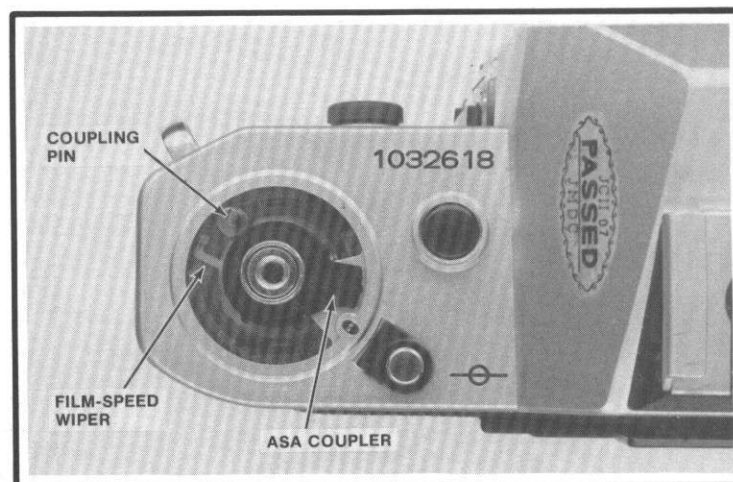

Figure 8



Figure 9

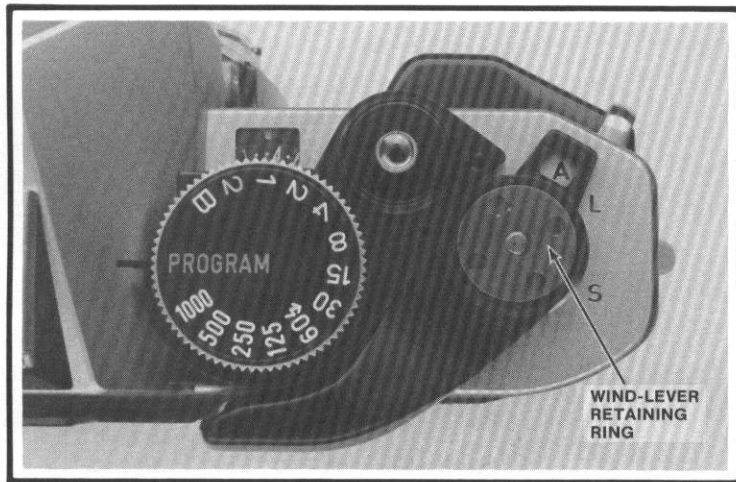

Figure 10

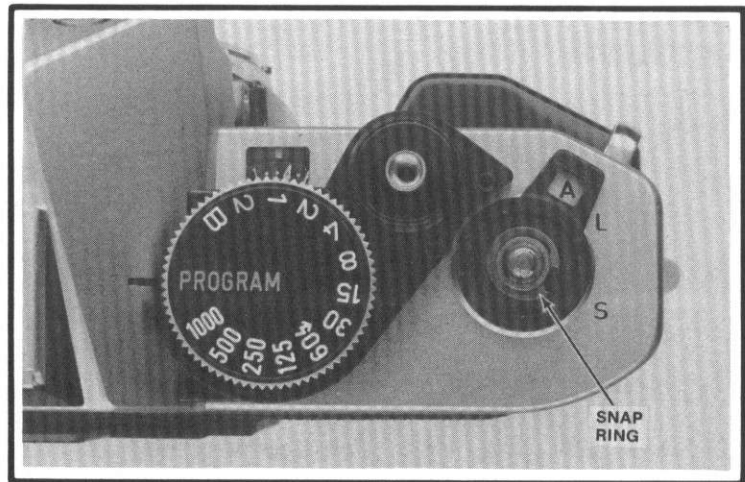

Figure 11

8. Remove the finger rest, Fig. 9, by taking out its two screws.
9. Unscrew the wind-lever retaining ring, Fig. 10. Note the 2 loose washers between the retaining ring and the wind lever. The wave washer goes next to the retaining ring, and the plastic washer goes next to the wind lever.
10. Lift off the wind lever and the winding seat. The tab on the winding seat goes up, pointing to the back of the camera.
11. Remove the SL Lever by taking off its snap ring, Fig. 11. In newer models, there's a wave washer under the SL lever. Also, in newer cameras, there's a tight-fitting spacer over the shaft of the SL Wiper. Remove both the wave washer and the spacer.
12. Set the shutter-speed knob to the program setting.
13. Lift aside the top cover. Three wires still connect the top cover to the camera.
14. Unsolder the black wire from the P.C. terminal inside the top cover, Fig. 12.
15. Unsolder the green wire and the white wire from the flex, Fig. 12.

You can now replace the winding seat and the wind lever to operate the camera. To release the shutter, push down the two switches normally operated by the release button—SW1 and SW2, Fig. 13. Closing just SW1 should turn on the LED display.

Be sure to note the position of the film-speed wiper, Fig. 13, at ASA 100. You'll want the film-speed wiper at the ASA 100 position for the exposure adjustments. If you accidentally turned the film-speed wiper, you can find ASA 100 by locating the brush under the coupling pin. Turn the film-speed wiper until the brush rests on top of the first contact to the front of the camera—that's ASA 12. Now count the contacts as you turn the film-speed wiper counterclockwise. When the brush is on the tenth contact, you've set ASA 100.

Also note the position of the SL wiper, Fig. 13. The SL wiper has three positions—A (on), L (lock), and S (self-timer). Turning the SL wiper fully counterclockwise sets the A position. The camera should then operate. Turn the SL wiper one click stop clockwise for the L position. Here, the SL wiper disconnects battery power from the circuit; the LEDs will not turn on and the shutter will not release.

Set the self-timer function by turning the SL wiper to the third click-stop position in a clockwise direction. You should now get the 10-second self-timer delay when you push down SW1 and SW2.

Reassembly, top cover:

1. Set the shutter wiper, Fig. 13, to the program position—the slot in the shutter wiper then faces the front of the camera.
2. Solder the black, green, and white top-cover wires, Fig. 12. Route the black wire under the piezo beeper, Fig. 14. Route the green and white wires so they don't interfere with the film-speed wiper or the battery-test switch, Fig. 13.
3. Seat the top cover. Replace the top-cover screws, the SL lever, the winding seat, and the wind lever.
4. Seat the ASA coupler, Fig. 8, with its pin in the top-cover slot.
5. Seat the film-speed dial with its hole over the pin on the film-speed wiper.
6. Place the wave washer on top of the film-speed dial.
7. Seat the film-speed cover with its index aligned at ASA 100. The film-speed cover should click into place as its two tabs key to the two slots in the ASA coupler.

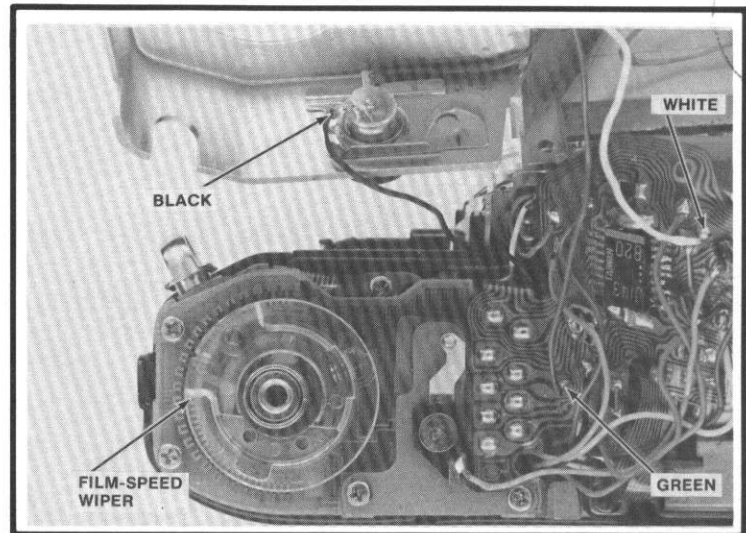

Figure 12

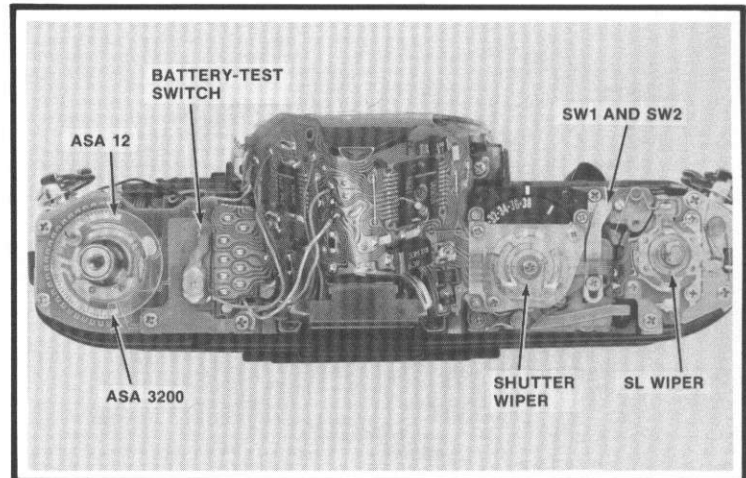

Figure 13

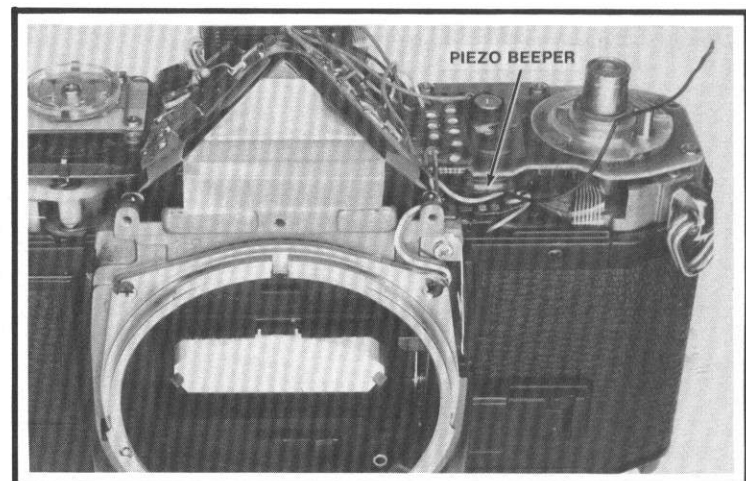

Figure 14

SECTION 3 — ADJUSTMENTS AND TESTS, WIND MECHANISM

Operation

The operation of the shutter and transport is nearly the same as in other A-series Canons. As you cock the shutter, the cam on top of the charge gear pushes the connecting lever, Fig. 15, from left to right. One end of the connecting lever then pushes the armature of MG2 against the permanent-magnet core.

Note: In Fig. 15, we have removed the insulating tape from the bottom of the flex circuit. Removing the insulating tape allows access to the circuit-test points. But be sure to replace the insulating tape, Fig. 5, before installing the bottom cover. Otherwise, the bottom cover may short the circuit to ground.

As the connecting lever charges the release magnet MG2, it also charges the mirror. A post on the connecting lever extends through a slot in the bottom of the body casting to engage the mirror-cocking mechanism. From the bottom of the camera, you can see the end of the mirror-lifting lever. Note that the mirror-lifting lever moves toward the front of the camera as you cock the shutter.

The mirror-lifting lever comes against the spring on the MG3 armature. So, as the mirror-lifting lever moves forward, it pushes the MG3 armature toward the core of the shutter magnet.

During the cocking stroke, the connecting-lever arm prevents the MG3 armature from touching the second-curtain cam. Then, at the end of the wind stroke, the spring-loaded connecting lever returns toward the wind-lever end of the camera. Now the MG3 armature moves against the core of the shutter magnet. And the latching surface of the MG3 armature drops into engagement with the second-curtain cam.

After the MG3 armature engages, switch SW5, Fig. 16, opens. In the AE-1, SW5 closes at the end of the cocking cycle to provide a ground connection as well as to signal the power winder; poor SW5 contact then causes a failure of the shutter to release. But in the AE-1 Program, the shutter can only release when SW5 opens. Poor contact in SW5 may then affect the power-winder operation, but the shutter will still operate.

The count switch SW4, Fig. 16, closes with the shutter cocked. As in the AE-1, SW4 serves as a timing switch. When SW4 opens, the circuit starts timing the shutter speed.

When you close SW1 and SW2, capacitor C1 discharges through the coil of the hybrid release magnet MG2. MG2 now repels its armature. The armature moves toward the front of the camera and releases the mirror.

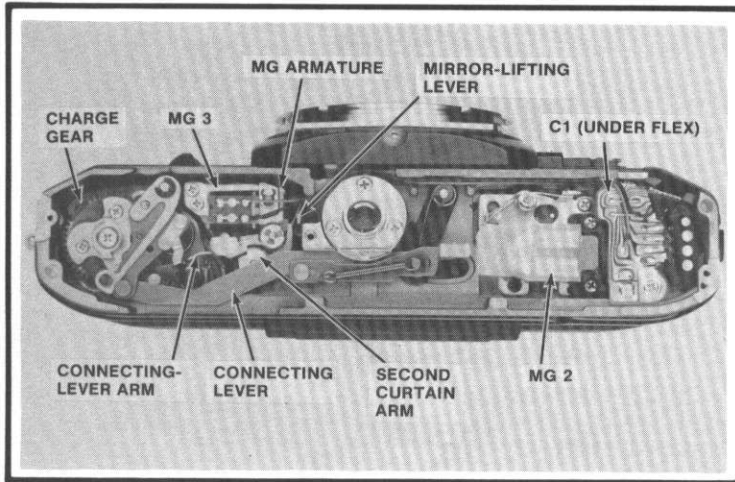

Figure 15

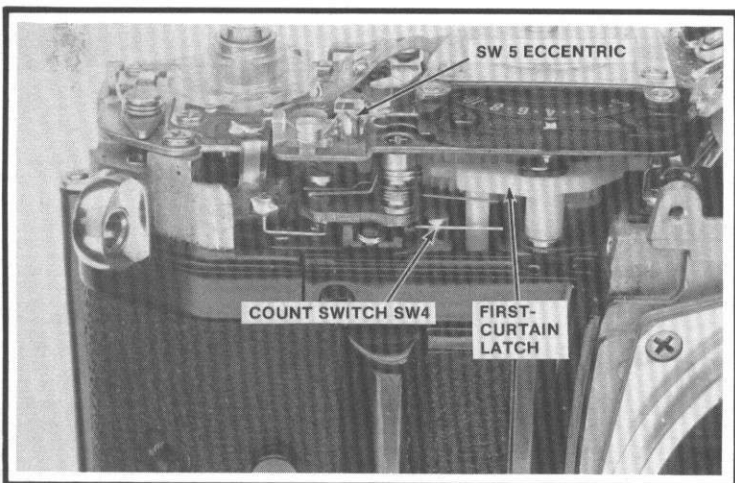

Figure 16

The mirror moves up and strikes the first-curtain latch, Fig. 16. As the first-curtain latch disengages the first curtain, it opens the count switch SW4. Now the timing circuit starts counting digital pulses. As the timing circuit counts, current flows through MG3. MG3 holds the MG3 armature engaged with the second-curtain cam to hold the second curtain.

Once the timing circuit reaches the proper count, it shuts off the MG3 current. MG3 now releases the second curtain. At the end of the exposure, SW5 closes to signal the power winder.

Curtain-travel Times, adjustment:

Adjust the curtain-travel times at 1/1000. You can reach the tension-setting gears through the clearance cutouts in the MG2 base, Fig. 17. Turn the tension-setting gears counterclockwise to add tension (faster travel times) or clockwise to let off tension (slower travel times).

Since the shutter uses Delrin gears, the recommended travel times are faster than in the AE-1. Set the curtain-travel times to 10.5ms for a 34mm distance (Canon standard). If your tester measures across a 32mm distance, set the travel times to 9.9ms.

MG2 and MG3, test procedures

Unlike the AE-1, magnets MG2 and MG3 receive power only with SW1 closed. Without closing SW1, you should measure 0V to both magnets. Closing SW1 connects the E1 voltage (close to the battery voltage) to MG2 and MG3.

To check MG2, close SW1. Now, with the shutter cocked, short the MG2 signal lead, Fig. 17, to the ground screw. MG2 should repel its armature and release the mirror.

Alternately, you can simply measure the voltage to each MG2 lead. If you don't measure the operating voltage at the E1 lead with SW1 closed, the problem is in the circuit. But if you measure the voltage at the E1 lead and not at the signal lead, MG2 has an open coil. You can measure the coil resistance (90 Ω) between the two MG2 leads.

You can also check MG3 by measuring the voltages to the two leads, Fig. 18. An open in MG3 causes a failure of the shutter to release. Check for the E1 voltage at the red lead with SW1 closed. If you get the E1 voltage at the red lead, but not at the black lead, MG3 has an open coil.

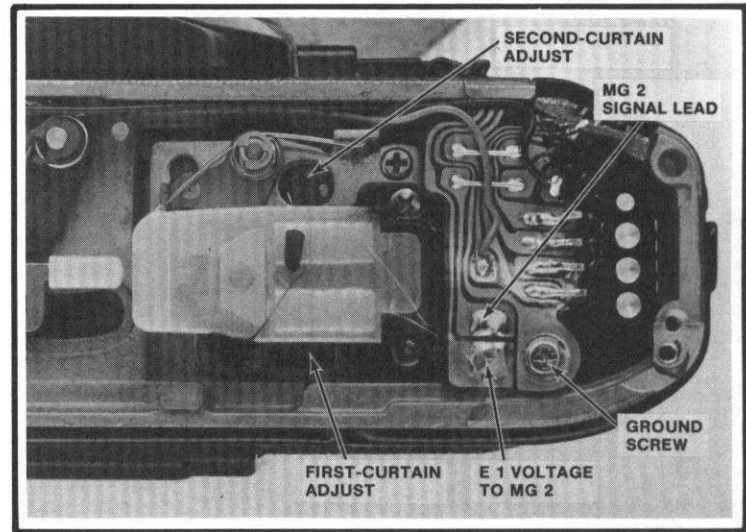

Figure 17

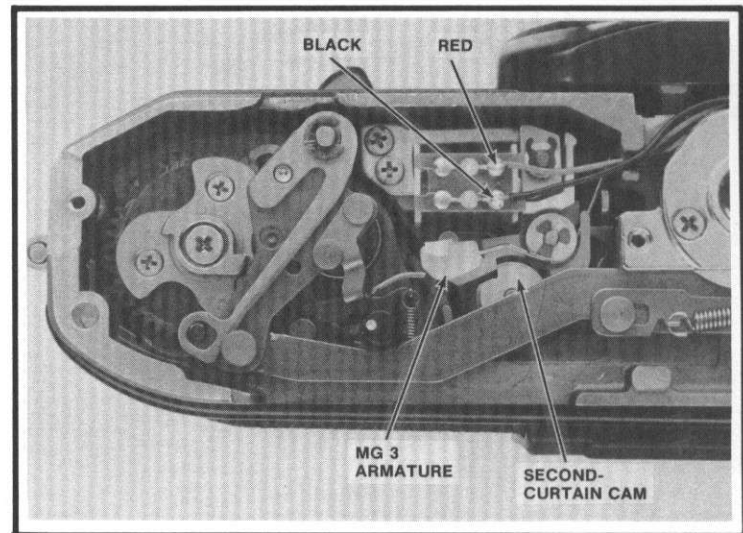

Figure 18

Second-curtain latch, adjustment

The AE-1 Program uses a minus latch for the second curtain. A minus latch means that, with the shutter cocked, there's no space gap between the latching surface of the MG3 armature and the latching surface of the second-curtain cam, Fig. 18. All Canon A-series cameras that provide automatic shutter-speed control use the minus latch to improve the accuracy.

As you cock the shutter, you should see the second-curtain cam rotate slightly beyond the latching surface of the MG3 armature. However, with the shutter cocked, there should be no space gap between the latching surfaces. To check for proper engagement with the shutter cocked, pull the MG3 armature out of engagement with the second-curtain cam. When you allow the MG3 armature to spring back into engagement, it should again fully engage the cam notch.

Adjustment on the second-curtain cam should not be necessary unless you have replaced shutter parts. To make the adjustment, first loosen the two setscrews that hold the second-curtain cam to the second-curtain shaft. Then rotate the second-curtain cam.

Wind Sequence, test

As you cock the shutter, the following actions should occur in sequence:

1. The first-curtain latch should engage the first-curtain gear.
2. The MG3 armature should engage the second-curtain cam as the connecting lever returns.
3. The transport latch should engage the wind-shaft notch (top of camera), allowing SW5 to open.

To check the sequence, slowly advance the wind lever. Watch the first-curtain latch, Fig. 16. When you see the first-curtain latch drop into engagement, stop advancing the wind lever. The MG3 armature should not as yet be engaged with the second-curtain cam.

Next advance the wind lever until the connecting lever snaps back toward the wind-lever end of the camera. The moment the connecting lever returns, check SW5—SW5 should still be closed. As you then complete the wind stroke, SW5 should open.

SW5, adjustment

SW5 has an eccentric adjustment for proper operation, Fig. 16. To check the adjustment, slowly advance the wind lever. Stop advancing the wind lever the moment the connecting lever returns. Now try to release the shutter by closing SW1 and SW2. If SW5 is properly adjusted, the shutter will not release.

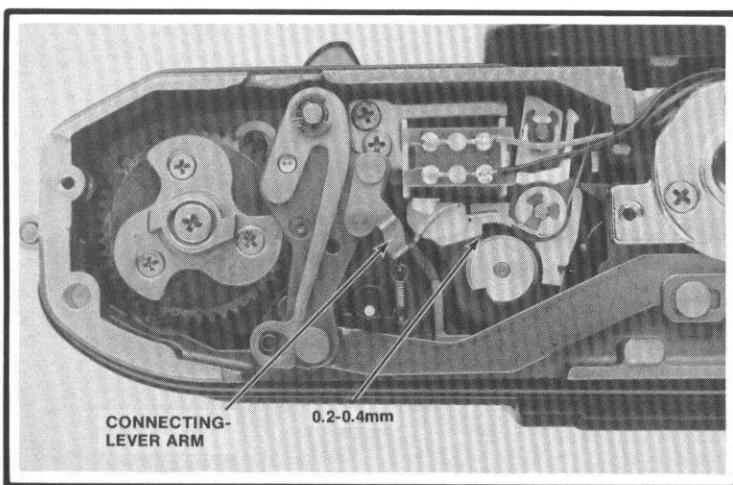

Figure 19

When you complete the wind stroke, SW5 should open. Now you should be able to release the shutter. To make the adjustment, first advance the wind lever until the connecting lever just returns. SW5 should still be closed. Turn the SW5 eccentric contact counterclockwise until it touches the wire contact.

Next turn the eccentric contact slightly further in a counterclockwise direction—a distance equal to the width of the eccentric screwdriver slot. The additional distance assures good contact pressure.

Now complete the wind stroke. When SW5 opens, there should be a space gap of at least 0.15mm between the wire contact and the eccentric contact.

Connecting-lever Arm, adjustment

The connecting-lever arm prevents the MG3 armature from contacting the second-curtain cam during the cocking cycle. To check, advance the wind lever until the charge cam has pushed the connecting lever the maximum distance—as far as the connecting lever will move toward the rewind end of the camera. There should now be a space gap of 0.2-0.4mm between the edge of the second-curtain cam and the MG3 armature, Fig. 19. Adjust by bending the connecting-lever arm.

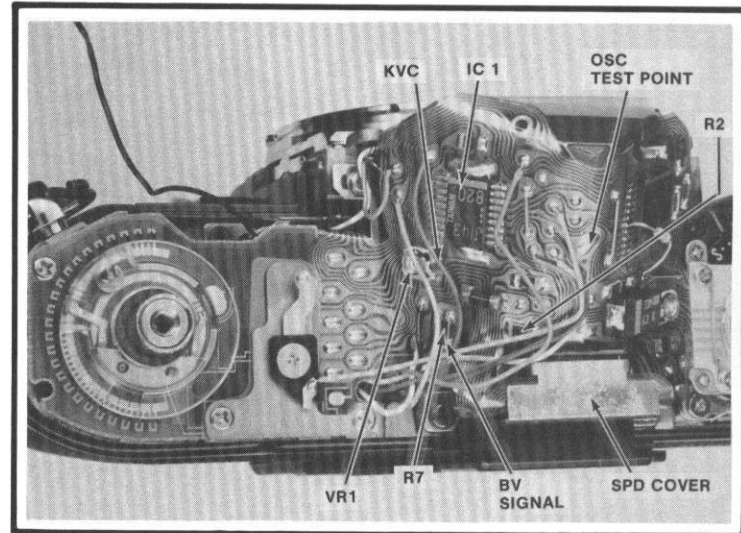

Figure 20

SECTION 4 — CIRCUIT

General

The circuit provides digital control of shutter speeds and diaphragm openings using four IC's—

IC1. Analog and digital IC located on the rewind side of the flex, Fig. 20. IC1 contains the amplifier for the linear signals, the digital driver for the three magnets, and the oscillator for the 32 KHz clock signal.

IC2. Digital CPU (central processing unit) located on the wind side of the flex, Fig. 21.

IC3. Digital decoder/driver for the LED display, located on the LED display board (under the film-speed base plate).

IC4. Linear amplifier for the SPD (silicon photodiode) located above the eyelens. The SPD is built into IC4. IC4 also supplies the constant-voltage source for the Vc reference voltage.

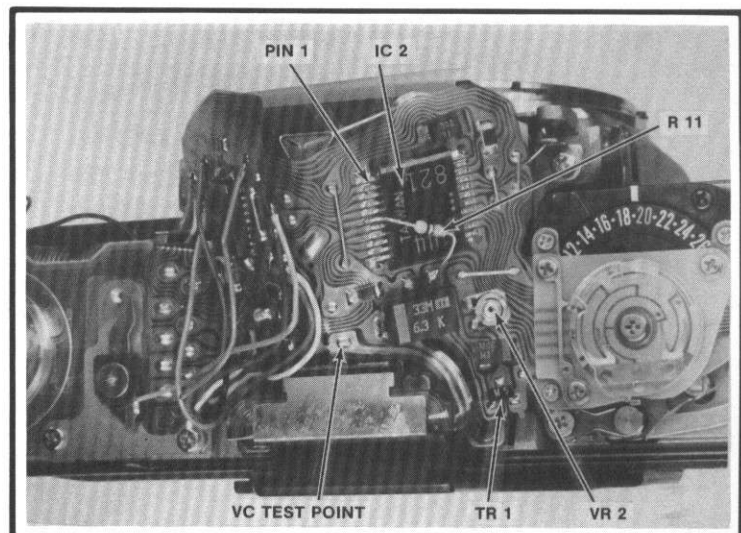

Figure 21

The block diagram, Fig. 22, shows the basic operation. A MOS amplifier serves as a log compressor, converting the SPD current to a voltage. The linear outputs of the MOS (BV), the film-speed resistor (SV), and the maximum-aperture resistor (AVO) are added and converted to a digital signal.

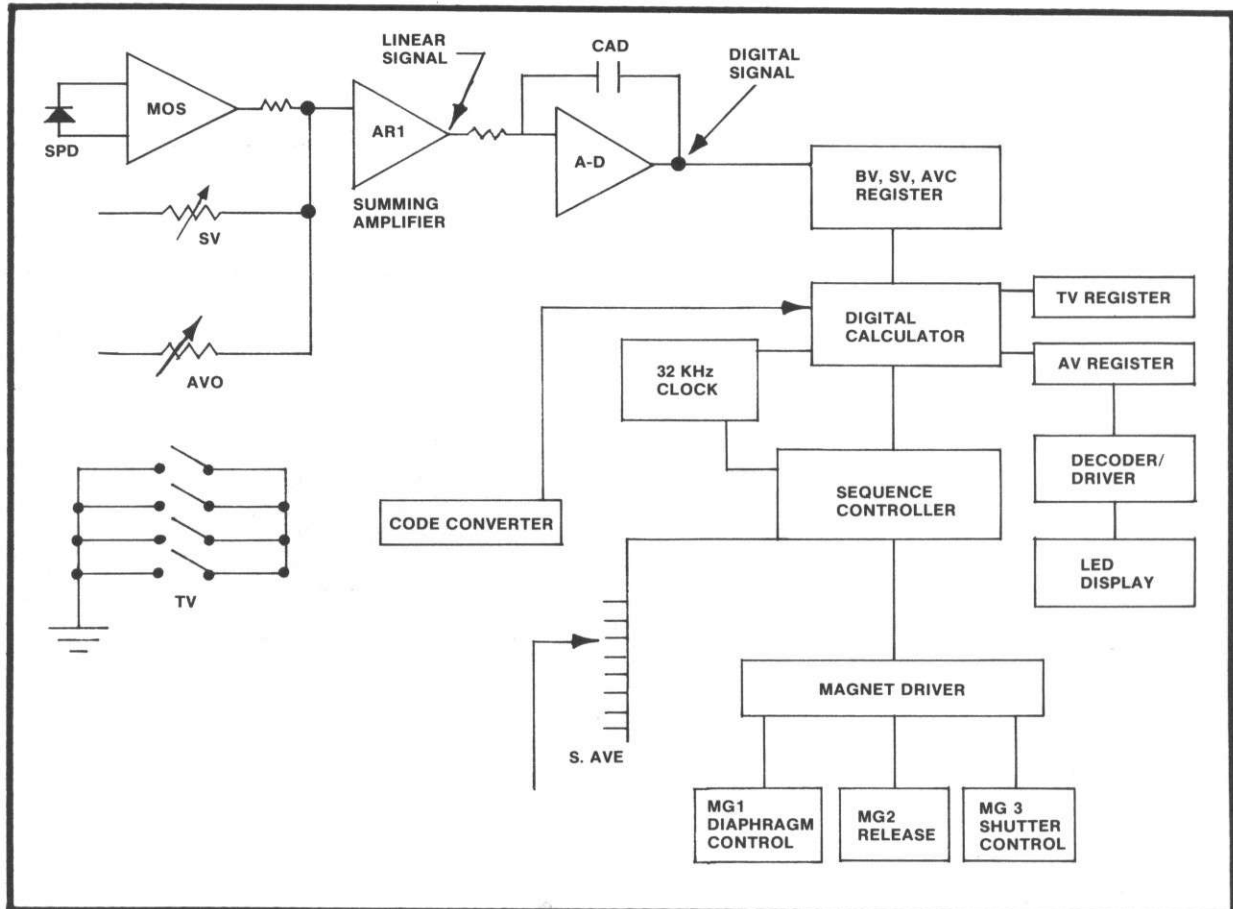

Figure 22

Amplifier A-D, the analog-to-digital converter, provides the signal conversion. The digital signal from amplifier A-D goes to a digital memory. A storage register memorizes the digital signal that corresponds to the brightness value, the speed value, and the maximum aperture.

The count stored in the BV/SV/AVC (aperture value correction) register provides one reference for determining the actual aperture. The second factor—the shutter-speed setting—comes from the TV switches. Setting the shutter speed by turning the shutter wiper opens or closes switches, supplying the TV signal in natural binary code. A code converter converts the natural binary code to Gray code.

A separate register, the TV register, stores the count for the shutter-speed information. Now the digital calculator determines the proper f/stop from the information in the

two registers. The digital calculator stores the f/stop information in the AV register. A decoder/driver decodes the digital count in the AV register and turns on the proper LED in the viewfinder display.

At the program setting, the digital calculator refers to a fixed program to determine the combination of shutter speed and diaphragm opening. It then stores the shutter-speed information in the TV register and the diaphragm information in the AV register.

When you close SW2 to release the shutter, the registers lock in the digital counts. The sequence controller now has the references it needs to control the magnets. First the sequence controller, after giving the registers time to reach their maximum counts, notifies the magnet driver to send current through MG2. On the self-timer setting, the sequence controller waits 10 seconds before giving the release signal.

Next the sequence controller must determine when to shut off the diaphragm-control magnet MG1. As the diaphragm closes, it moves the S.AVE (segmented aperture-value electrode) contact. The S.AVE contact now sends a digital signal to the sequence controller.

The sequence controller compares the count received from the S.AVE contact to the count stored in the AV register. When the two counts are equal, the sequence controller shuts off the current flowing through MG1. MG1 then releases its armature to stop the diaphragm at the proper diaphragm setting.

When the mirror releases the first curtain, the sequence controller determines how long the shutter magnet MG3 should hold the second curtain. The sequence controller counts clock pulses supplied by an oscillator. A comparator compares the number of clock pulses to the count stored in the TV register. When the counts are equal, the sequence controller signals the magnet driver to shut off the current flow through MG3.

Switch Locations and Functions

The switch numbers in the AE-1 Program correspond to those in other A-series Canons.

SW1— metering switch, controlled by the release button.

When you push the release button part way, SW1 closes to supply E1 voltage to the IC's and magnets.

SW1¹— preview switch at the side of the lens mount. Performs the same function as SW1.

SW2— release switch, controlled by the release button. SW2 is under SW1.

SW4— count switch at the front of the first-curtain latch. Closed with the shutter cocked, opens when the first-curtain latch moves forward to release the first curtain. When SW4 opens, the timing circuit starts counting clock pulses.

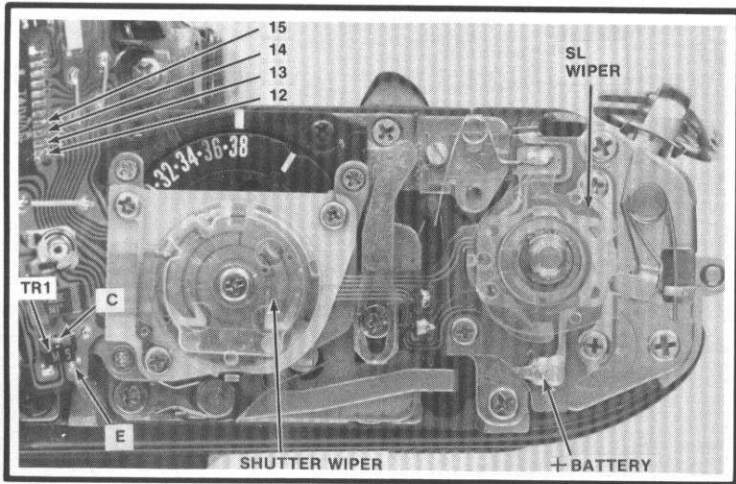

Figure 23

- SW5— power-winder, motor-drive switch operated by the transport latch. Closed with the shutter released, opens when you cock the shutter.
- SW7— self-timer switch. Closes when you turn the SL contact to the self-timer position.
- SW8— battery-test switch on top of the film-speed base plate. Closes when you depress the battery-test button, turning on the sound-drive oscillator to power the piezo beeper.
- SW9— memory switch on the side of the lens mount. Pushing the AE-lock button closes SW9 to lock the information in the storage registers.
- SW11— auto/manual switch at the back of the front plate. Setting the lens to a manual f/stop closes SW11. SW11 opens at the auto setting of the lens.
- SW12— TV switches controlled by the shutter wiper.
- SW0— on/off switch controlled by the SL wiper. When you turn the SL contact to the A setting, SW0 closes.

Circuit Power

The battery voltage appears at the red wire to the SL switch board, Fig. 23. You should measure the full battery voltage between ground and the red wire regardless of the switch position. Turning the SL wiper to the A position, Fig. 23, connects the battery voltage to the emitter of transistor TR1, Fig. 24, by closing switch SW0.

When you now close metering switch SW1, TR1 turns on. The E1 voltage (battery voltage minus the voltage drop across the transistor) appears at the TR1 collector. Turning on TR1 supplies the E1 voltage to the four IC's and to the three magnets.

The check system built into IC1 prevents the camera from operating if the battery voltage drops too low. The check system also prevents operation if there's an open in MG2 or MG3; an open magnet results in a failure of the shutter to release. Similarly, the check system prevents the shutter from releasing if the count switch SW4 makes poor contact.

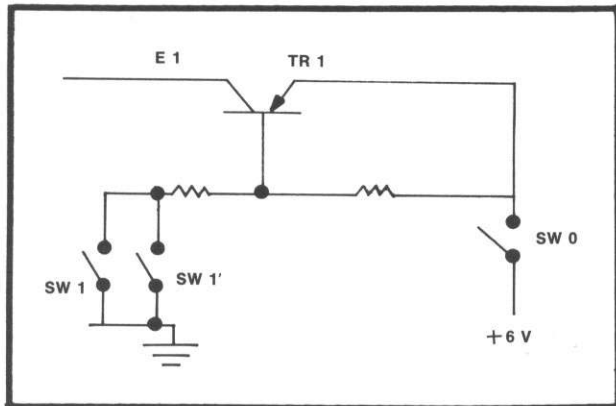

Figure 24

Constant Voltages

With SW1 closed, the circuit supplies two constant voltages—Vc, the 1.3V reference voltage for the amplifiers and comparators, and KVc, the 1.6V adjustment voltage.

IC4 supplies the 1.3V Vc voltage. With SW1 closed, you should measure the Vc voltage at the Vc test point, Fig. 21. No voltage reading indicates a defective IC4.

IC1, Fig. 20, supplies the 1.6V KVc voltage. The KVc voltage is applied to variable resistor VR1, the auto-exposure adjustment. You should measure KVc at the VR1 lead indicated in Fig. 20 with SW1 closed. No voltage reading indicates a defective IC1.

Clock Signal

IC1 contains the oscillator that supplies the clock signal. You can check the clock signal at the OSC test point, Fig. 20. If you're using an oscilloscope, you should measure the 32 KHz square-wave signal shown in Fig. 25. However, you can make a voltage reading to check for the presence of the clock signal. A voltage of 0.7V at the OSC test point indicates that the clock signal is present.

The clock serves as the timing signal for the circuit functions. Each timing circuit counts clock pulses rather than sensing voltage levels. A frequency divider counts down the basic 32 KHz frequency to provide the different time controls.

When you close SW2 to release the shutter, the oscillator provides the slight delay that allows the counters time to reach their maximum counts. On the self-timer function, the oscillator delays the MG2 current for 10 seconds.

The oscillator signal also goes to the decoder/driver for the LED display. Here, the frequency divider provides the signal that allows the decoder/driver to sample new information every 0.5 second. Also, the frequency divider provides the 2 Hz signal that causes the LEDs to flicker as warning indications.

At the CPU, the clock provides the timing signal for the shutter speeds. The CPU counts clock pulses and compares the count with the references stored in registers.

A failure of the oscillator then causes the same malfunction as a bad battery—the shutter won't release, and the LEDs won't turn on. If nothing works electronically, checking the clock signal should be one of your first tests.

Light Measurement

The light-measuring circuit uses a silicon photodiode (SPD or SPC) that measures the brightness value from the focusing screen. IC4, the linear amplifier for the SPD signal, contains the built-in photodiode.

To reach IC4, lift out the SPD cover that clips to the top of the eyelens assembly, Fig. 20. You can then lift up the section of flex containing IC4, Fig. 26. When you reseal the flex, position IC4 behind the tab on the SPD fresnel-lens frame; position the ends of IC4 between the two positioning lugs.

The MOS amplifier in IC4 converts the current changes through the SPD to voltage changes. As the light level increases, the output of the MOS goes more positive. The diode in the MOS feedback circuit provides log compression to compress the brightness range of the subject to a range the circuits can handle.

Amplifier AR5, also inside IC4, Fig. 27, amplifies the output of the MOS. The BV voltage signal appears at pin 4 of AR5. Since AR5 is an inverting amplifier, the BV output goes more positive as the light level decreases.

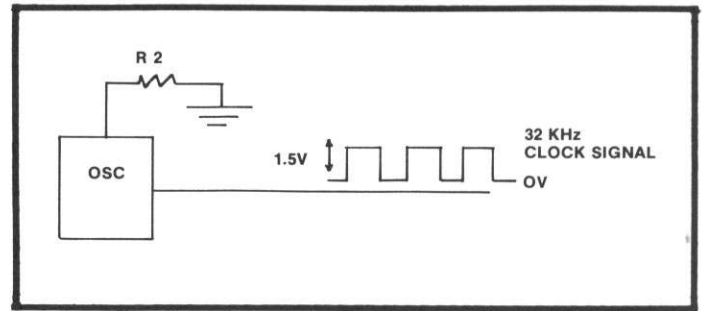

Figure 25

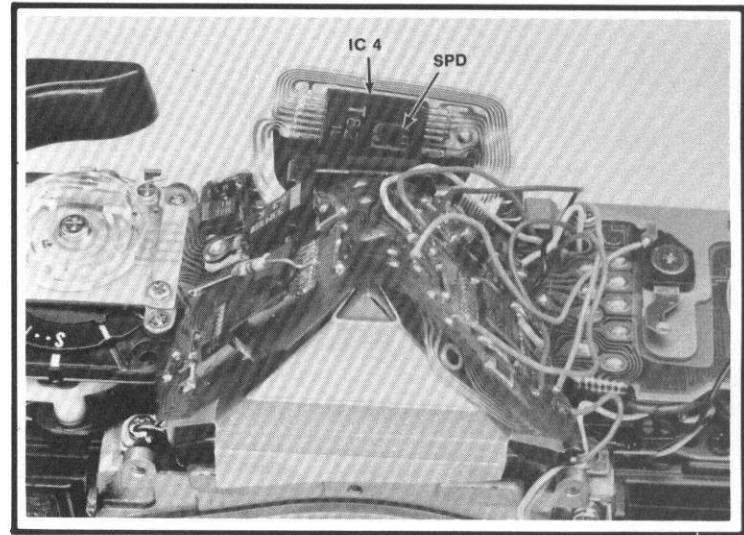

Figure 26

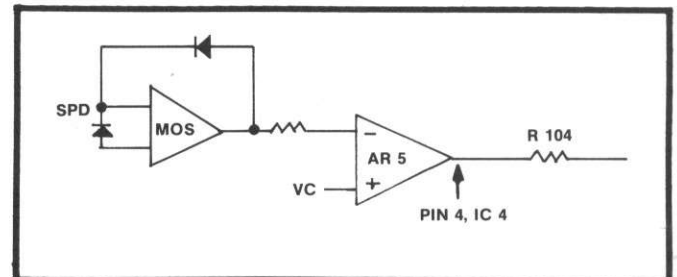

Figure 27

You can check the pin 4 voltage without lifting out IC4. Measure the voltage at the end of resistor R7, Fig. 20, with SW1 closed. The voltage should be around 1.5V with the top cover removed. If you cover IC4 to reduce the light reaching the SPD, the voltage should increase; the voltage should decrease if you allow more light to strike the SPD.

IC4 also contains the AVO amplifier for the maximum-aperture information. The post on the back of the lens determines the resistance of the maximum-aperture resistor VR102, Fig. 28. In turn, VR102 determines the output of amplifier AVO.

The output of AVO goes to the AVC (aperture-value correction) amplifier inside IC1, Fig. 28. Next the film-speed resistor inputs the film-speed setting as a resistance value, Fig. 28. All three variables—the brightness value, the film speed, and the maximum-aperture information—go to summing amplifier AR1, Fig. 29.

AR1, a linear amplifier, adds together the three variables. The linear output signal must then be converted to a digital signal for processing in the CPU. An analog-to-digital converter in IC2 provides the signal conversion.

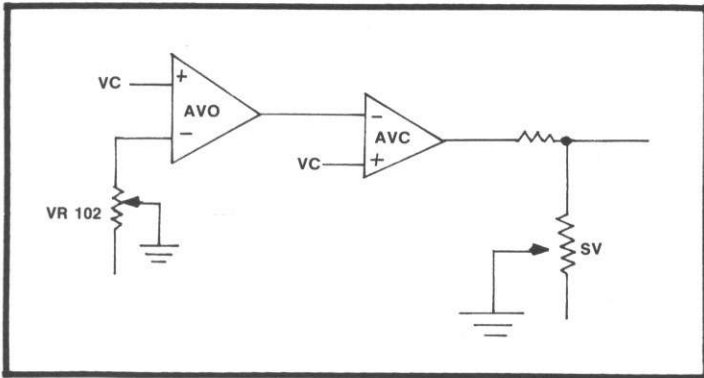

Figure 28

A-D Converter

Amplifier AD in IC2, Fig. 29, uses a capacitor CAD (capacitor analog-to-digital) in the feedback path. The linear metering signal at the inverting input of AD controls the charge time of CAD.

If the light level increases, the metering signal goes more positive. CAD then charges more quickly. When the light level decreases, the input signal goes less positive. And CAD charges more slowly.

Yet the discharge time of CAD remains constant—regardless of the input signal. CAD always discharges through a fixed resistor. One slope of the output signal, Fig. 29, then varies according to the input signal. The other slope remains constant.

Changing one side of the output slope varies the length of the peak, Fig. 29. The output of AD can then be converted to a digital pulse—the length of the pulse depends on the input variables.

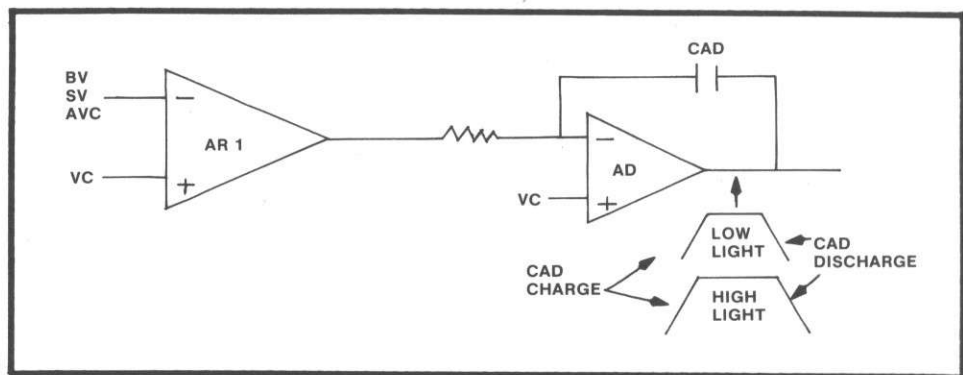

Figure 29

The digital signal goes to the CPU where it's stored in a register. As the CPU processes the information, it refers to the exposure register for the light level, film speed, and maximum aperture.

You can check the A-D signal as one test of IC2. Touch the oscilloscope probe to pin 1 of IC2, Fig. 21, and close SW1. At the scope settings of 0.05 v/cm and 2ms sweep time, you should get the A-D signal. One side of the trace should change as you change the light level.

Aperture Control

When you depress SW2 to release the shutter, the circuit locks the exposure information in the storage registers. The CPU now calculates the proper f/stop from the information received from the A-D converter and the information received from the shutter-speed setting. The result of the calculation determines the count stored in the AV register, Fig. 30.

The circuit then knows what f/stop to set. But the CPU still needs to know the actual diaphragm position—how far the diaphragm has closed. This information comes from the segmented aperture-value electrode—S.AVE, Fig. 30.

As the diaphragm closes, the S.AVE wiper moves along a series of contacts, Fig. 30. The resulting digital signal goes to a comparator. The comparator compares the S.AVE count to the count stored in the AV register.

When the two counts are equal, the comparator shuts off the current flowing through the diaphragm-control magnet MG1, Fig. 30. MG1 then releases its armature to arrest the diaphragm at the proper f/stop.

Shutter-speed Control

The signal that tells the CPU what shutter speed you've selected doesn't have to go through an analog-to-digital converter—it's already a digital signal. The shutter wiper, Fig. 23, controls the signals at pins 12, 13, 14, and 15 of IC2. The signal at each pin is either high (around 1.6V) or low (0V).

Fig. 31 shows how the shutter wiper controls the pin signals. The shutter wiper opens or closes the four TV switches. When a particular TV switch is open, the signal at the pin connected to the switch is high. Closing that switch then shorts the pin signal to ground for the low input.

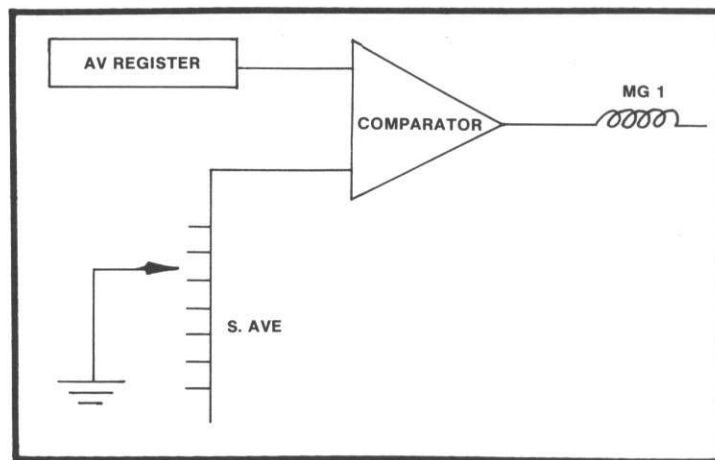

Figure 30

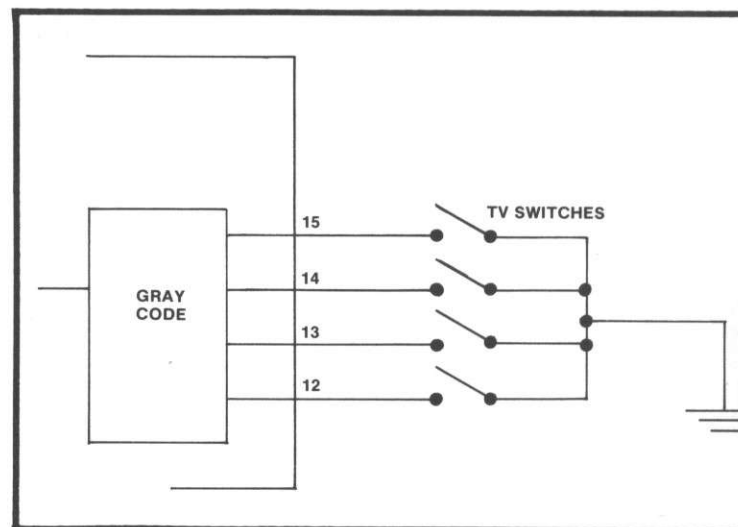

Figure 31

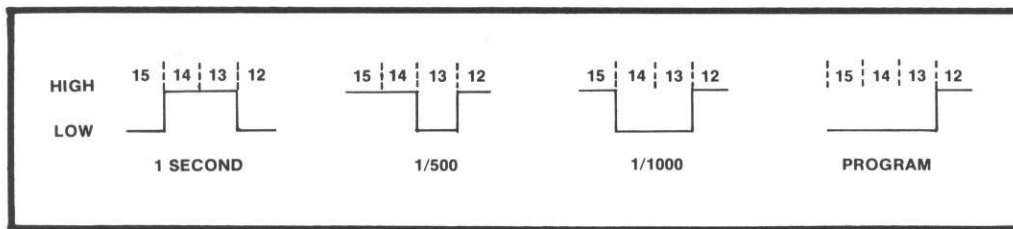

Figure 32

Each setting of the shutter wiper results in a different combination of signals at the four IC2 pins. Fig. 32 compares the input signals at four settings. You can check the input signals by measuring the pin voltages of IC2, Fig. 23. If a particular pin fails to switch to 0V, the problem may be poor contact in the TV switch connected to that pin. But if a pin fails to switch to 1.6V, the problem is probably a defective IC2.

The CPU processes the digital signal from the TV switches and stores the count in the shutter-speed (TV) register. Now the CPU knows how long it must allow MG3 to hold the second curtain.

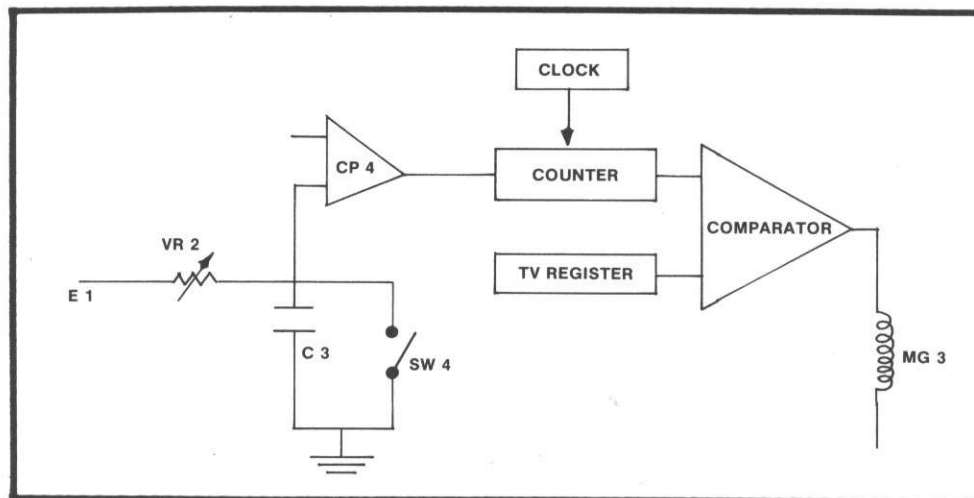

Figure 33

When the mirror releases the first curtain, the first-curtain latch opens the count switch SW4, Fig. 33. Opening SW4 allows capacitor C3 to start charging. When C3 reaches the trigger voltage, the timing circuit starts counting clock pulses supplied by the oscillator.

A comparator compares the clock count with the count memorized in the TV register, Fig. 33. When the two counts are equal, the comparator shuts off the current flowing through MG3. MG3 then releases the second curtain to end the exposure.

The sooner the count switch opens, the sooner C3 starts charging. On fast shutter-speed settings, the moment that the count switch opens has a significant effect on the exposure time. Here, the clock count quickly reaches the count

stored in the TV register. At slow-speed settings, however, the moment that the count switch opens has very little effect.

You can therefore adjust SW4 as a fast-speed control. At the 1/1000 setting, you can bend SW4 to correct the accuracy. Bending the SW4 wire contact toward the first-curtain latch causes the count switch to open sooner—a faster shutter speed. But you normally don't have to bend SW4. Variable resistor VR2, Fig. 33 and Fig. 21, provides a fast-speed adjustment. VR2 affects the charge time of C3. The faster C3 charges, the sooner the circuit starts counting clock pulses.

VR2 has very little effect on the slow speeds. There's only one slow-speed adjustment—the frequency of the oscillator that supplies the clock pulses. You can change the oscillator frequency by changing the value of resistor R2, Fig. 25 and Fig. 20. The adjustment procedure is described in Section 13. However, unless you replace IC1, you should never have to make the frequency adjustment.

Sound-drive Circuit

A separate oscillator inside IC2 drives the piezo beeper—both for the self-timer function and for the battery-test function. When you close the battery-test switch SW8, load resistor R11 draws battery current, Fig. 34. R11 connects across the top of IC2, Fig. 21.

If the battery voltage under load is at least 3.5V, the sound-drive oscillator in IC2 supplies a 4 KHz signal to the piezo beeper, Fig. 34. A steady 4 KHz signal would cause the beeper to emit a continuous tone. To get the beeping indication, IC2 interrupts the 4 KHz signal. The frequency of the interruption signal changes to get the different beeping frequencies.

A battery voltage of 4.8V or higher causes the circuit to interrupt the 4 KHz oscillator 6.5 times a second. The frequency of the interruption signal decreases as the battery voltage decreases.

Closing the self-timer switch SW7, Fig. 34, again turns on the 4 KHz sound-drive oscillator. But the self-timer oscillator signal is 5V peak-to-peak compared to 2.5V peak-to-peak for the battery test. The piezo then beeps louder on the self-timer function.

For the first 8 seconds of the self-timer delay, the circuit interrupts the 4 KHz signal at a rate of 2 Hz. The frequency of the interruption signal increases to 8 Hz for the final 2 seconds of the delay.

The piezo beeper sits under the film-speed base plate. Unlike most cameras using piezo beepers, The AE-1 Program has no sound-emitting hole. Rather, the entire camera body serves as a resonator for the beeper.

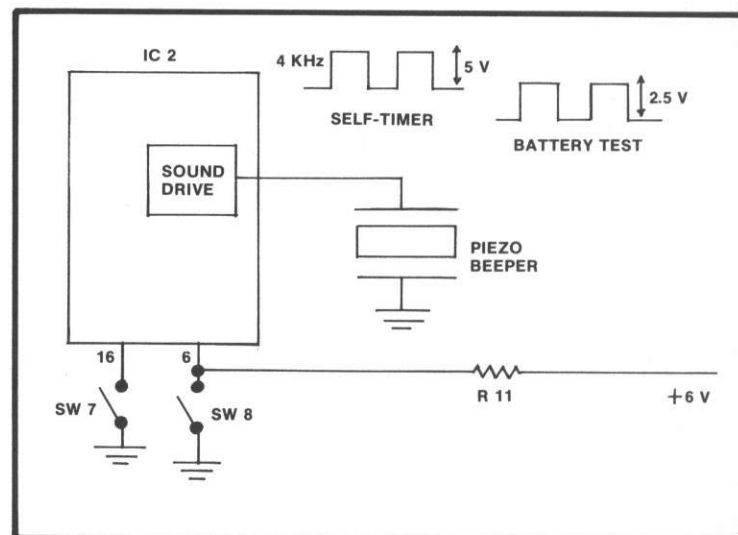

Figure 34



Figure 35

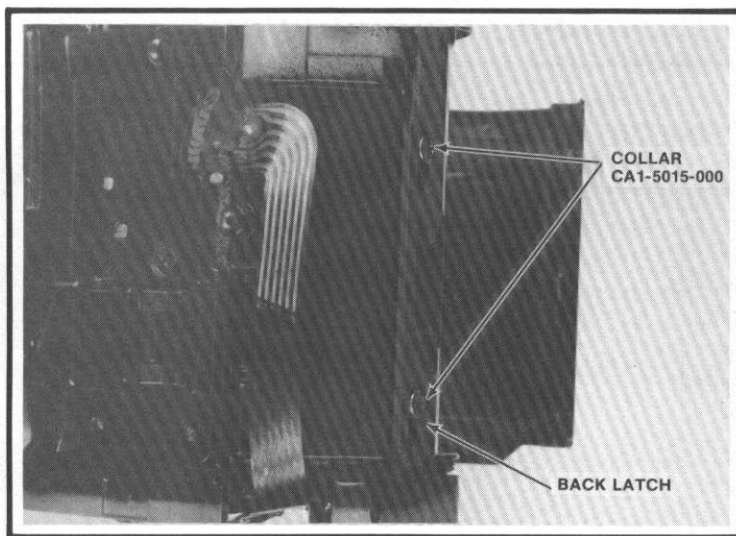

Figure 36

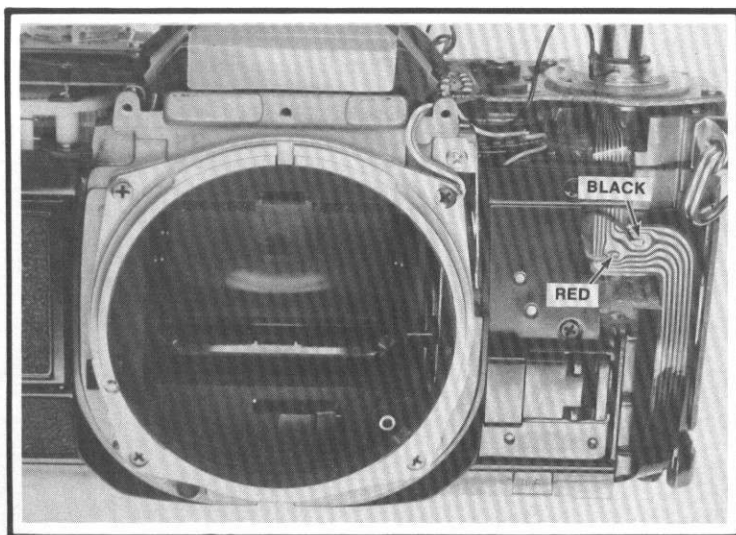

Figure 37

SECTION 5 — REMOVING THE MIRROR ASSEMBLY

Since the circuit only receives power with SW1 closed, it's unlikely that you'll do any damage when unsoldering wires. However, it's still a good safety precaution to remove the battery before unsoldering.

1. Peel off the right and left front sections of leatherette, Fig. 35.
2. Remove the cover plate at the rewind side of the camera body (1 short screw in front, 2 longer screws at the end of the camera body).
Caution: The spacers for the back latch will be loose, Fig. 36, when you remove the cover plate. You can hold the spacers (collars) in place by temporarily replacing the cover-plate end screws as shown in Fig. 36.
3. Unfold the section of flex circuit covering the MG1 connections, Fig. 37.
4. Unsolder the red and black MG1 wires from the flex, Fig. 37.
5. Unsolder the wires indicated in Fig. 38 from the top of the flex.
6. Remove the film-speed wiper by taking off its snap ring.
7. Remove the battery-test ground plate with the battery-test switch (2 screws holding the ground plate), Fig. 38.
8. Remove the screws holding the film-speed base plate. There may be only one screw at the end of the film-speed base plate.
9. Lift up the film-speed base plate to reach the piezo beeper, Fig. 39.
10. Remove the 3 screws holding the piezo beeper. The long screw goes to the front of the camera. You can now see the LED display board with IC3, Fig. 40.
11. Remove the 2 upper mirror-housing screws from the back of the camera (1 on each side of eyepiece).

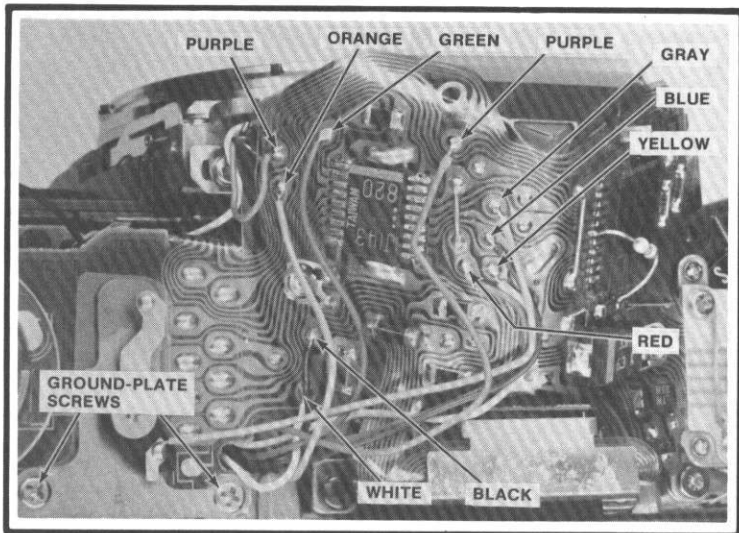

Figure 38

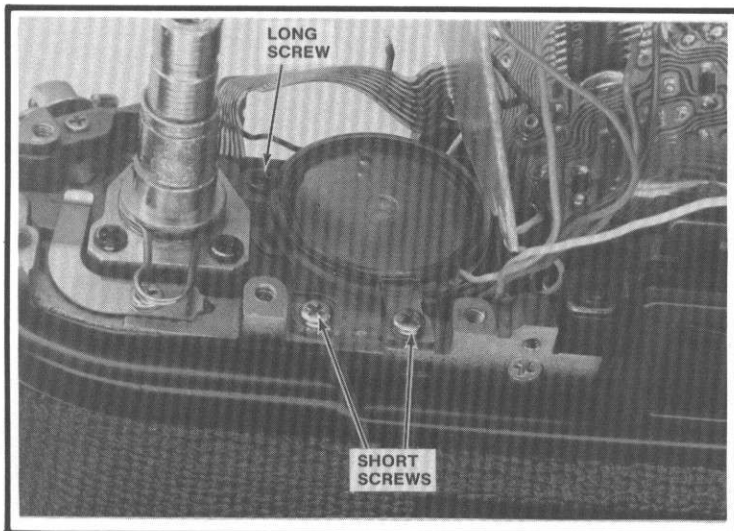

Figure 39

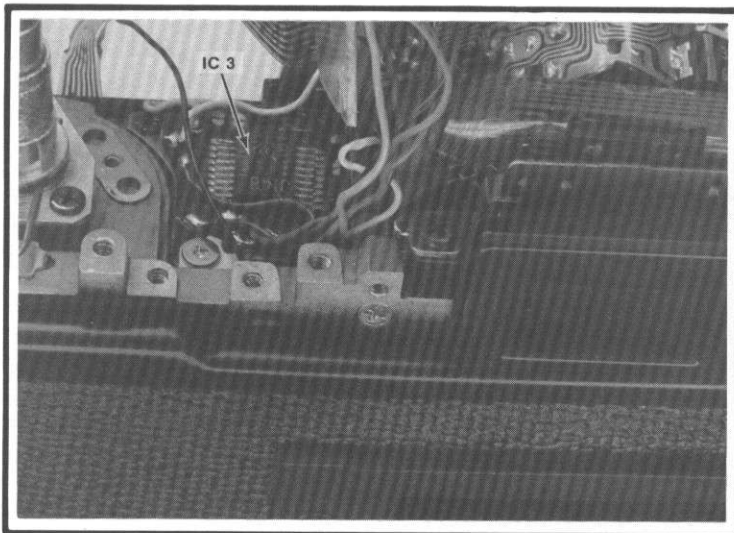

Figure 40

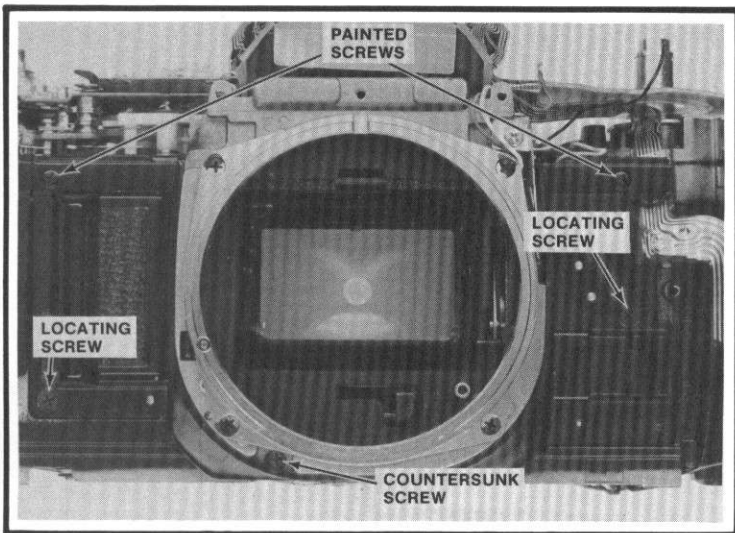

Figure 41

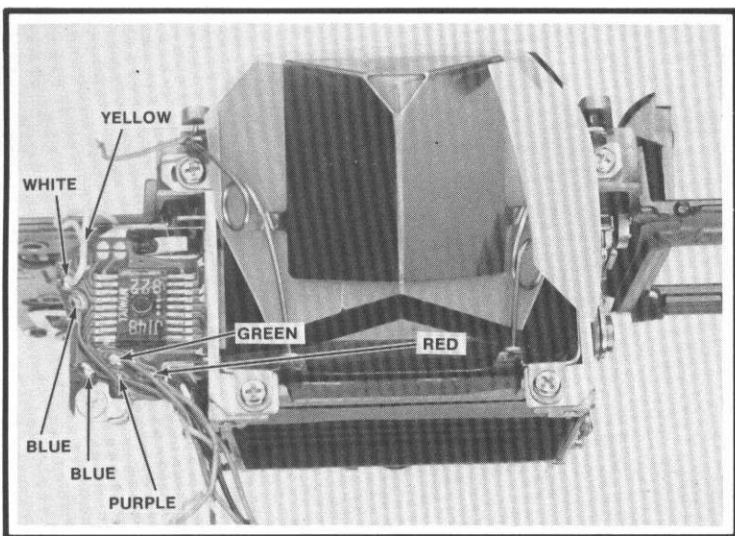

Figure 42

12. Remove the 5 front-plate screws, Fig. 41. Note that 2 of the screws have locating shoulders. Remove the locating screws last (because they're likely to be very tight with the other screws in place). Replace the locating screws first.
13. Open the battery compartment. Then, inserting your thumb into the battery compartment for a grip, lift out the front-plate/mirror-housing assembly, Fig. 42.
Note: It's possible to remove the front-plate/mirror-housing assembly without taking out the piezo beeper. However, it's difficult to seat the front-plate/mirror-housing assembly with the piezo beeper in place. Removing the beeper also prevents possible damage to the LED display board, Fig. 42.

Replacing the front-plate/mirror housing assembly:

1. Make sure the shutter is in the released position. To release the shutter, push the first-curtain latch, Fig. 43, toward the back of the camera.
2. Make sure the MG2 armature is in the released position (away from the core of MG2).
3. Make sure the mirror is in the released position with the mirror down.
4. Clean the inside surface of the eyelens before replacing the mirror assembly.
5. As you seat the mirror assembly, pass the wires, Fig. 42, under the film-speed base plate, Fig. 43. The ends of the wires should be accessible at the back of the camera.
6. Seat the front-plate/mirror-housing assembly. Check to make sure the end of the mirror-lifting lever is to the outside of the MG3-armature spring (between the spring and the tripod socket).
7. Hold the mirror housing in position as you cock the shutter. The wind lever should latch after the cocking stroke. If you can continue advancing the wind lever, the mirror housing hasn't seated properly.

8. Install the two locating screws in the front plate. Then replace the remaining front-plate screws and the two screws by the eyepiece.
9. Route the section of flex that extends to the bottom of the camera between the piezo beeper and the film-speed base plate.
10. Check the mechanical operation before resoldering the wires. To release the mirror, push the MG2 armature toward the front of the camera. The mirror should rise, the shutter should release, and the mirror should return.
11. Solder the MG1 wires, Fig. 37. Fold the insulator section of the flex on top of the MG1 connections; tuck the end of the insulator section under the front plate.
12. Replace the piezo beeper and seat the film-speed base plate.
13. Replace the battery-test switch.
14. Replace the film-speed wiper.
15. Resolder the wires, Fig. 38, and test the operation.
16. Replace the cover plate at the end of the camera body and the leatherette.

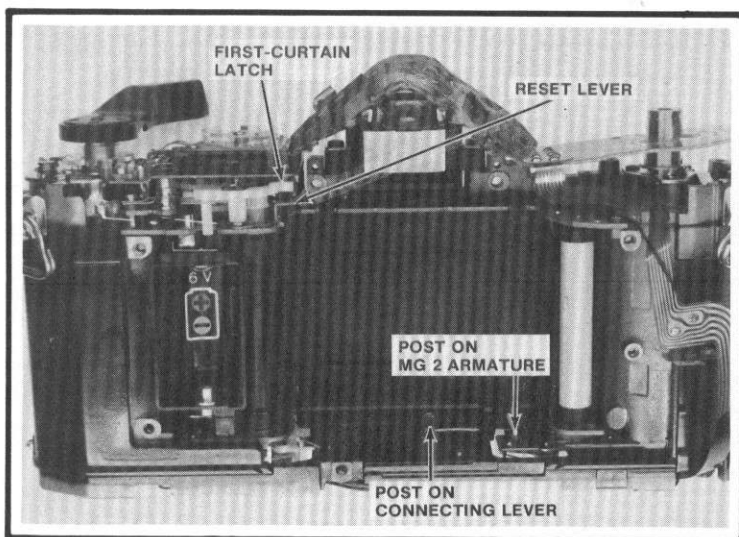

Figure 43

SECTION 6 — OPERATION OF THE MIRROR ASSEMBLY

The mirror operation is nearly identical to that in other A-series Canons. Cock the mirror by pushing the main charge lever, Fig. 44, in a counterclockwise direction. The MG1 armature now moves against the core of the diaphragm-control magnet.

Unlike the early AE-1's, the diaphragm-control magnet in the AE-1 Program has a white plastic cover. The parts around MG1 have been treated with an oil dispersant to reduce oil contamination on the magnet interface. Oil on MG1 causes the lens to program too small an aperture. Since the armature sticks, it can't arrest the diaphragm closure quickly enough. However, because of the plastic cover, you can't clean MG1 from the bottom of the camera; it's necessary to remove the mirror assembly.

Release the mirror by pushing the U-shaped end of the reset lever, Fig. 44, toward the front of the mirror assembly. A spring now drives the diaphragm-charge lever, Fig. 44, counterclockwise. The end of the diaphragm-charge lever moves away from the end of the mirror-lifting lever and strikes the mirror latch, Fig. 45.

Disengaging the mirror latch allows the mirror-lifting spring, Fig. 45, to pull the mirror-lifting lever in a clockwise direction. An arm on the mirror-lifting lever comes against a post on the mirror bracket, driving the mirror to the raised position.

The diaphragm-charge lever also operates the diaphragm-closing lever, Fig. 44. A pawl on the diaphragm-charge lever engages the tab on the diaphragm-closing lever. As the diaphragm-closing lever rotates counterclockwise, the pawl carries the diaphragm-closing lever in the same direction. The end of the diaphragm-closing lever, passing through the lens mount, allows the lens diaphragm to stop down.

Without a lens installed, you may find that the pawl sometimes fails to pick up the tab on the diaphragm-closing lever. The diaphragm-charge lever then moves counterclockwise without driving the diaphragm-closing lever in the same direction. If the pawl fails to pick up the tab, the lens diaphragm won't close.

Simulate the spring action of the diaphragm by putting slight finger pressure on the diaphragm-closing lever (from the front of the lens opening). Now release the mirror. The pawl on the diaphragm-charge lever should remain engaged with the tab on the diaphragm-closing lever. If not, the pawl may be worn. You can either replace the diaphragm-charge lever (CF1-1454-000) or the complete auto diaphragm unit (CG1-0807-020).

To return the mirror and reopen the diaphragm, push forward the mirror-return lever, Fig. 45. The mirror-lifting lever now moves counterclockwise—away from the post on

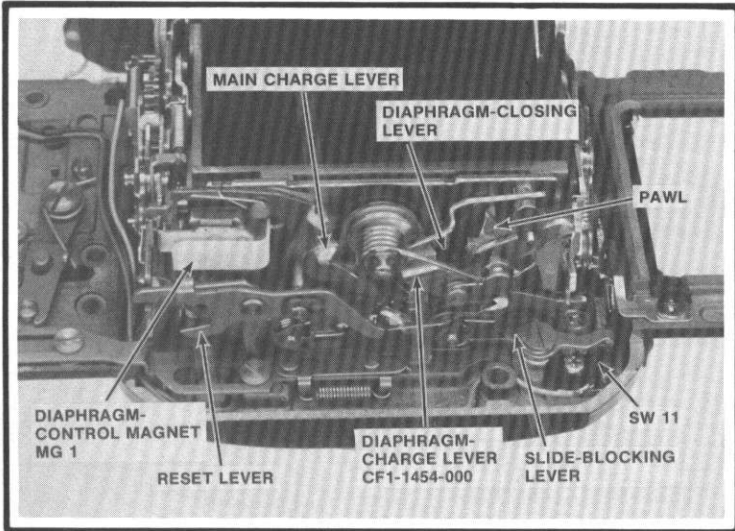

Figure 44

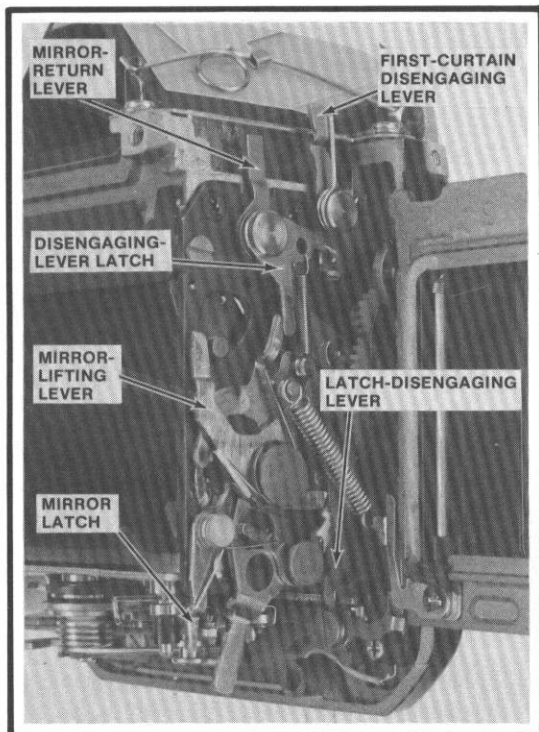

Figure 45

the mirror bracket. The spring-loaded mirror then returns to the down position.

Pushing forward the mirror-return lever disengages the lifting-lever latch to free the mirror-lifting lever. The latch-disengaging lever that disengages the lifting-lever latch also disengages the pawl from the diaphragm-closing lever. Note that the lower end of the latch-disengaging lever, Fig. 45, comes against the pawl-disengaging lever. The pawl-disengaging lever pulls the pawl out of engagement with the tab on the diaphragm-closing lever, allowing the lens diaphragm to reopen.

In normal operation, the connecting-lever post, Fig. 43, charges the mirror. The post comes against the curved end of the main charge lever. A post on the MG2 armature, Fig. 43, strikes the U-shaped end of the reset lever to release the mirror.

The mirror then rises and releases the first curtain. An arm on the mirror-lifting-lever assembly strikes the disengaging-lever latch, Fig. 45. The first-curtain disengaging lever then moves toward the shutter and strikes the first-curtain latch, Fig. 43.

With the mirror housing removed, however, the first-curtain disengaging lever doesn't move. That's because the shutter must first charge the first-curtain disengaging lever. During the cocking stroke, the reset lever in the shutter, Fig. 43, pushes the first-curtain disengaging lever forward—until the first-curtain disengaging lever is latched by the disengaging-lever latch.

The second curtain returns the mirror. As the second curtain reaches the end of the aperture, the second-curtain brake lever moves forward. The second-curtain brake lever strikes the mirror-return lever.

At the other side of the mirror housing, you can see the AE unit, Fig. 46. The AE unit controls how far the diaphragm closes. Again, the operation is similar to that in the AE-1. But, rather than sensing the diaphragm closure with a resistor, the AE-1 Program uses a digital contact—the S.AVE (segmented aperture-value electrode) contact, Fig. 46.

Charging the mirror also charges the AE unit. The main charge lever drives the S.AVE reset lever, Fig. 46, toward the front of the mirror housing. Now the S.AVE control arm moves up until it latches on the top step of the control-arm latch, Fig. 47.

In the charged position, the S.AVE brush contact sits at the top end of the AE pattern board, Fig. 47. Then, when the mirror releases, the reset lever at the bottom of the mirror housing disengages the control-arm latch.

Now the lens diaphragm can close. As the diaphragm closes, it pulls down the diaphragm-control lever at the front of the lens opening. The diaphragm-control lever moves the S.AVE brush contact along the AE pattern board.

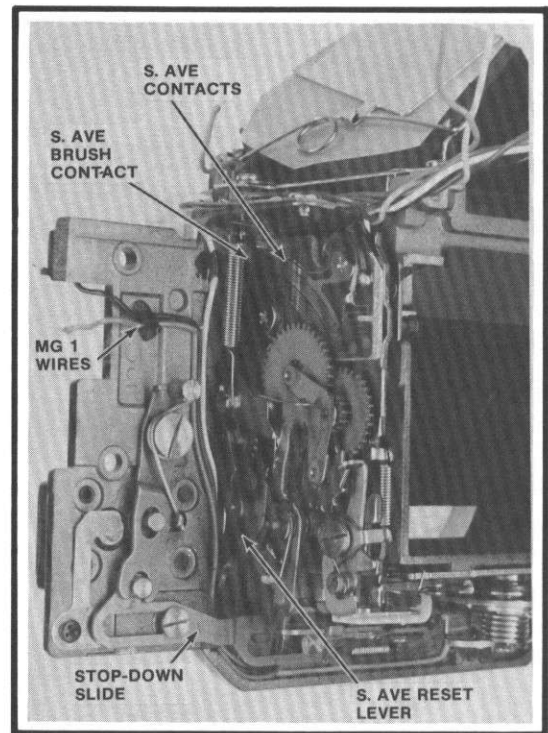

Figure 46

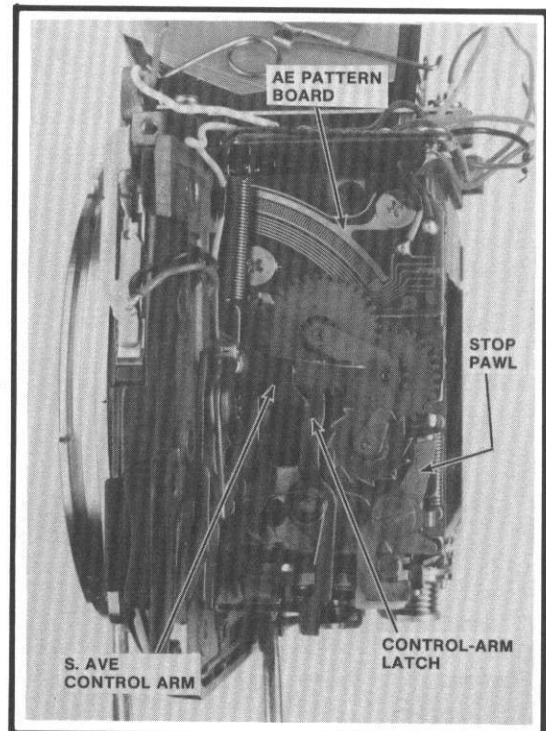

Figure 47

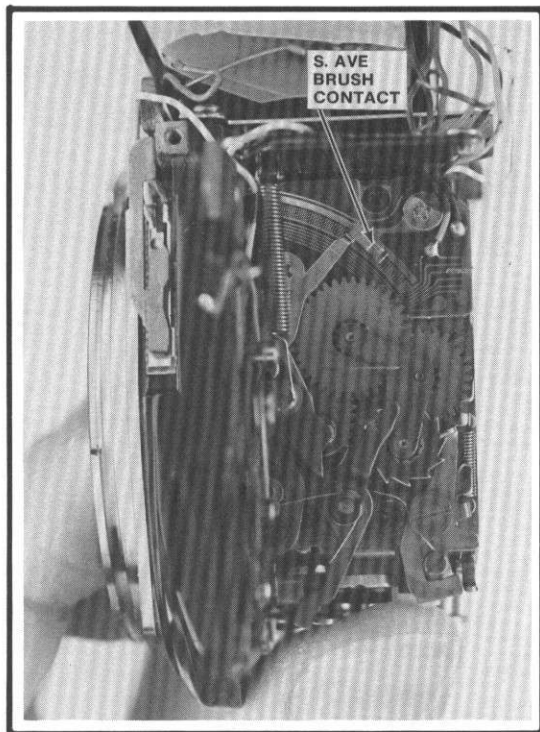

Figure 48

Each time the S.AVE brush touches a pattern contact, it shorts that contact to ground. The circuit sees a series of digital pulses as the diaphragm closes. A comparator compares the number of S.AVE pulses to the count stored in the AV register. When the counts are equal, the magnet driver shuts off the current flowing through MG1. MG1 releases its armature, allowing the stop pawl to engage the ratchet gear, Fig. 47.

Arresting the ratchet gear stops the downward movement of the diaphragm-control lever. As a result, the diaphragm-control lever stops the diaphragm at the proper f/stop. The S.AVE brush contact remains in place until you once again charge the mirror.

To check the S.AVE brush, use your thumb to simultaneously hold both the control-arm latch and the stop pawl disengaged. Now, from the front of the lens opening, pull down the diaphragm-control lever. The S.AVE brush should move along the AE pattern board, Fig. 48.

You can check the contact by hooking an ohmmeter between the orange wire to the AE pattern board and ground. With the mirror charged, the S.AVE brush should move off the first pattern contact. The ohmmeter should then indicate infinite resistance.

Now pull down the diaphragm-control lever while watching the ohmmeter. As the S.AVE brush moves along the AE pattern board, you should see the ohmmeter needle fluctuate between infinite resistance and 0 resistance.

The S.AVE contact only controls the diaphragm closure when the lens is at the auto setting. At auto, the pin at the back of the lens pushes in the EM change pin in the lens mount. The EM change pin then opens SW11, the auto/manual switch, Fig. 44.

Also, the EM change pin moves the slide-blocking lever, Fig. 44, into the path of the stop-down slide. The slide-blocking lever prevents you from using the depth-of-field preview on auto. To use the depth-of-field preview, you must first set a manual f/stop.

At the manual f/stop settings, the slide-blocking lever moves out of the path of the stop-down slide. Now you can push the stop-down lever to its latched position. As the stop-down slide moves from left to right, Fig. 46, its lug comes against the pivoted arm of the reset lever. The pivoted arm disengages the control-arm latch.

Disengaging the control-arm latch allows the lens diaphragm to close to the manual f/stop setting. The S.AVE brush moves to the corresponding position on the AE pattern board. If you now return the diaphragm-setting ring to the auto setting, you won't get an automatically controlled f/stop. It's first necessary to reset the S.AVE brush to the top of the AE pattern board.

To reset the S.AVE brush, rotate the diaphragm-setting ring to the maximum-aperture setting. The S.AVE control arm then moves up until it's latched by the notch in the

control-arm latch. You can now return the diaphragm-setting ring to the auto setting.

SECTION 7 — ADJUSTMENTS IN THE MIRROR ASSEMBLY

It's rarely necessary to make the mirror-housing adjustments. However, if you replace parts, check the following:

1. Overtravel, S.AVE control lever

Cock the mirror assembly and hold the main charge lever fully advanced (as far as it will go in a counterclockwise direction as seen from the bottom). There should be a space gap of at least 0.5mm between the top step of the control-lever latch and the S.AVE control lever, Fig. 49. Adjust by turning the eccentric on the S.AVE reset lever, Fig. 46, after loosening the lock screw.

2. Overtravel, armature-control lever

Cock the mirror assembly. There should now be a 0.05-0.1mm space gap between the edge of the armature-control lever and the eccentric, Fig. 50. Adjust by turning the eccentric.

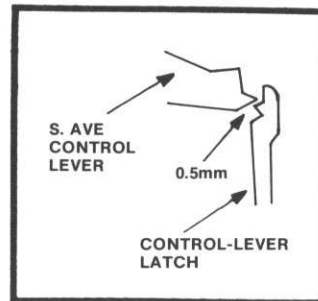

Figure 49

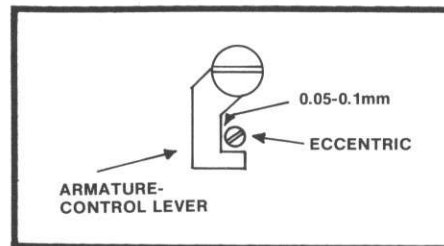

Figure 50

SECTION 8 — DISASSEMBLY OF THE MIRROR HOUSING

As in other A-series Canons, the three panels—the mirror mechanism, the AE unit, and the auto-diaphragm unit—attach to the sides of the mirror housing. You can remove the mirror mechanism, Fig. 45, individually. But remove the AE unit and the auto-diaphragm unit together.

Sequence to remove the mirror mechanism:

1. Peel back the cemented light trap at the back of the mirror housing to reach the mirror-return spring, Fig. 51.
2. The short end of the mirror-return spring hooks under the lip of the mirror housing, Fig. 51; the long end hooks to a post at the front of the mirror bracket. Disconnect the short end of the mirror-return spring by working through the cutout in the mirror housing, Fig. 51. Move the short end toward the cutout. Then allow the short end to pass through the cutout to the back of the mirror housing.

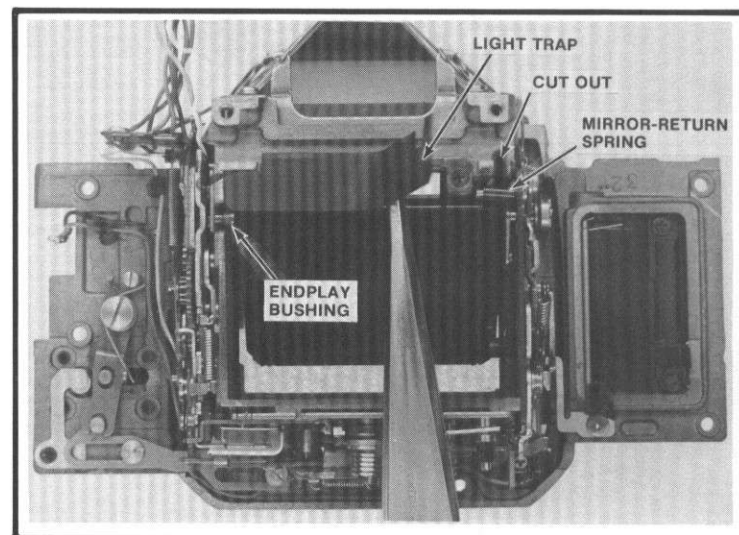

Figure 51

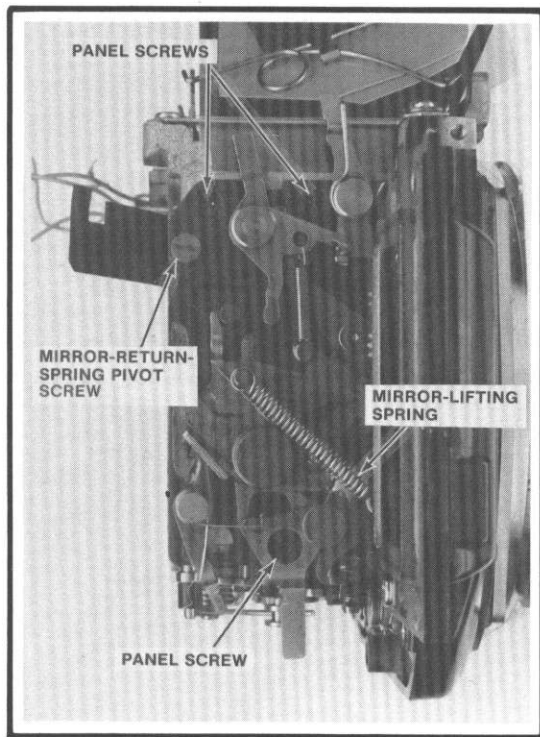

Figure 52

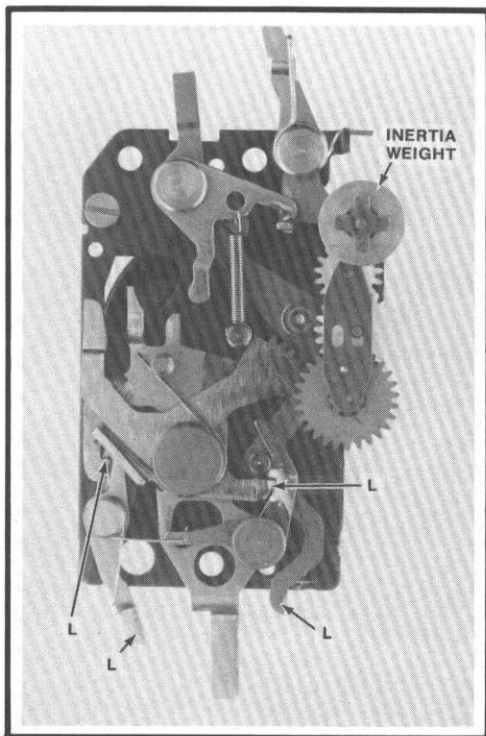

Figure 53 Mirror Mechanism

3. Disconnect and remove the mirror-lifting spring, Fig. 52.
4. Push the mirror-lifting lever to the charged position, Fig. 52. You can now reach all three screws holding the side panel. Remove the three screws and lift out the mirror mechanism, Fig. 53.
5. Lift out the mirror and the mirror-return spring. Watch for the loose endplay bushing on the mirror pivot, Fig. 51.

Sequence to replace the mirror mechanism:

The mirror mechanism, Fig. 53, is supplied as a complete unit for replacement purposes. Lubricate the mirror mechanism at the points marked "L" with a losoid grease. Put a drop of shutter oil on the inertia-weight pivot of the mirror governor.

1. Seat the endplay bushing over the mirror pivot, Fig. 51. Then seat the mirror.
2. Seat the mirror mechanism. Make sure the mirror latch sits behind the arm of the diaphragm-charge lever, Fig. 45. Also position the latch-disengaging lever behind the end of the pawl-disengaging lever, Fig. 45. Replace the three mirror-mechanism screws.
3. Back out the mirror-return-spring pivot screw, Fig. 52.
4. Position the mirror-return spring below the cutout at the back of the mirror housing, Fig. 51. The short end of the mirror-return spring goes toward the mirror mechanism.
5. Turn in the mirror-return-spring pivot screw. The pivot screw passes through the coils of the mirror-return spring.
6. Hook the long end of the mirror-return spring to the top of the mirror-bracket post (front of mirror).
7. Grasp the short end of the mirror-return spring with your tweezers. Push the short spring end through the cutout in the mirror housing. Then move the short spring end to your right until it hooks under the housing lip.
8. Replace the mirror-lifting spring.
9. Recement the light trap.

Sequence to remove the auto-diaphragm unit and the AE unit:

You can remove the auto-diaphragm unit and the AE unit without taking off the mirror mechanism. Since the diaphragm-control magnet MG1 mounts to the AE unit, though, it's difficult to individually remove the AE unit and the auto-diaphragm unit. You can more easily remove the two units together.

1. Unsolder the blue wire from the LED circuit board, Fig. 42.
2. Remove the cemented indicator plate at the front of the lens opening (the plate with the red dot that goes under the diaphragm-closing lever).
3. Pull the red and black MG1 wires loose from the cement on the back of the front plate, Fig. 54. The wires remain attached to MG1. You'll find it easier to reroute the wires if you first remove the stop-down slide.
4. Hold the S.AVE-contact latch and the locking pawl disengaged, Fig. 48. Now pull down the diaphragm-control lever until it aligns with the clearance slot at the front of the mirror housing, Fig. 55.

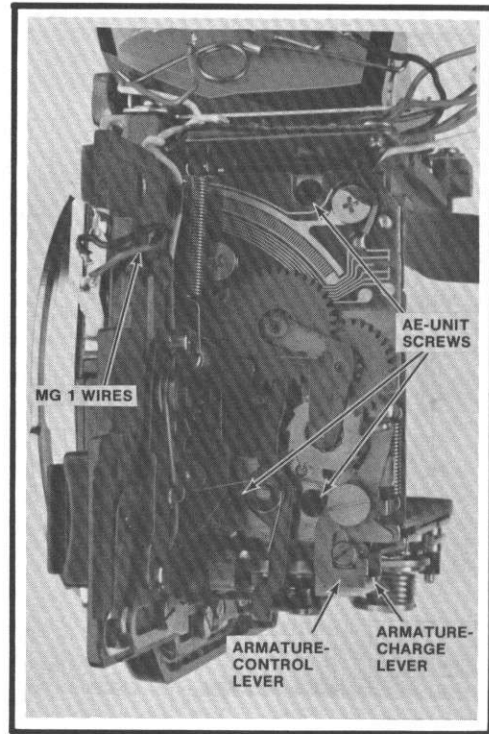

Figure 54

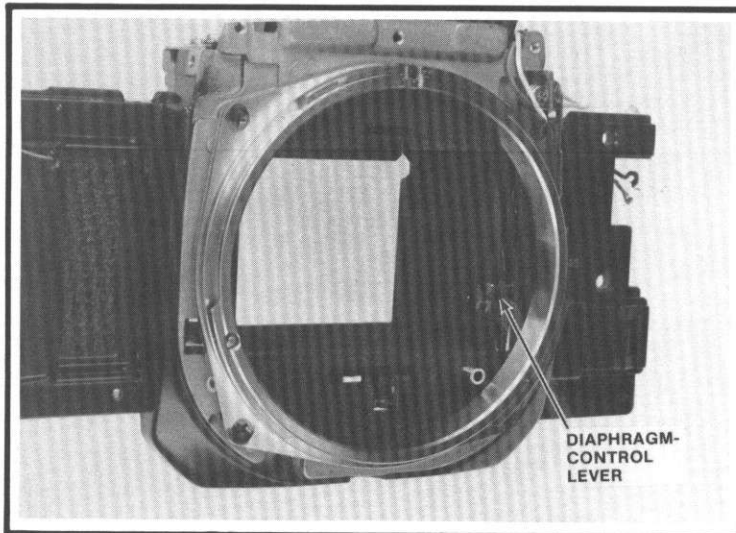

Figure 55

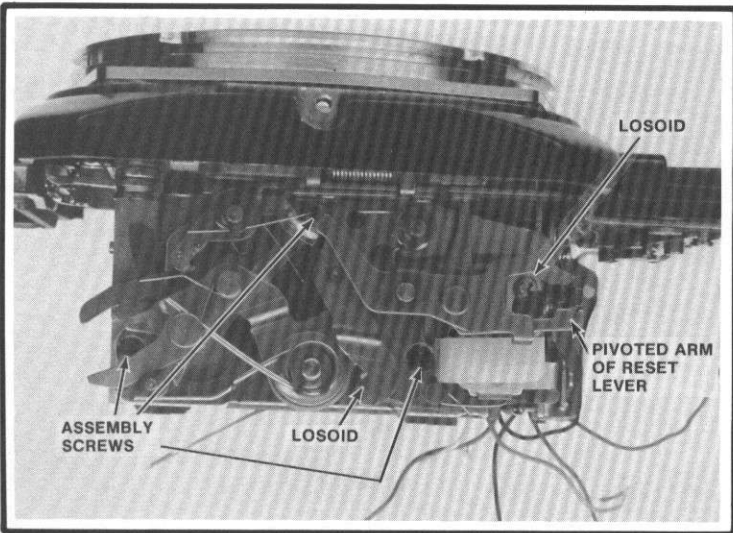

Figure 56 Auto Diaphragm Unit
CG1-0807-020

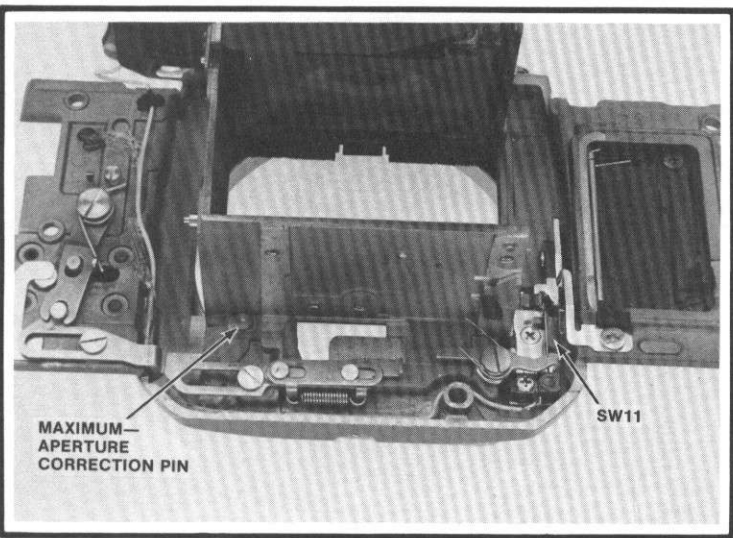

Figure 57

5. Remove the three screws holding the AE unit, Fig. 54. The screws for the AE unit are longer than the screws holding the other two units. Now pull the AE unit a slight distance from the mirror housing—that moves MG1 away from one of the screws holding the auto-diaphragm unit, Fig. 56.
6. Remove the three screws holding the auto-diaphragm unit, Fig. 56.
7. Lift out the AE unit and the auto-diaphragm unit together. Separate the two units after removing them from the mirror housing. The maximum-aperture correction pin, Fig. 57, is now loose.

Sequence to replace the auto-diaphragm unit and the AE unit:

On the back of the AE unit, Fig. 58, you can now reach the maximum-aperture resistor, Fig. 59. Clean the contacts of the maximum-aperture resistor before replacing the AE unit.

1. Seat the maximum-aperture correction pin, Fig. 57.
2. Assemble the AE unit to the auto-diaphragm unit. Make sure the pivoted arm of the reset lever hooks behind the S.AVE-contact latch, Fig. 56. Also hook the armature-charge lever behind the lower end of the armature-control lever, Fig. 54.
3. Seat the two units on the mirror housing, Fig. 60. The end of the diaphragm-control lever must pass through the slot in the side of the mirror housing, Fig. 55.
4. When both units are fully seated, replace the three screws holding each unit. The longer screws hold the AE unit.
5. Reroute the black and red MG1 wires and cement them to the front plate.

Other mirror-housing disassembly procedures:

1. To remove the pentaprism, disconnect and remove the two pentaprism-retaining springs, Fig. 42.
2. To remove the LED display board, take out the screw holding the board, Fig. 42. Then slide the LED display board away from the focusing screen.

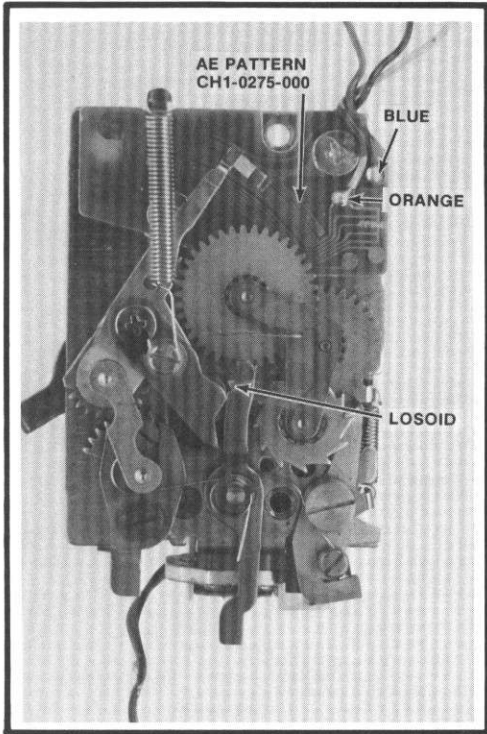

Figure 58 AE Unit CG1-0123-000

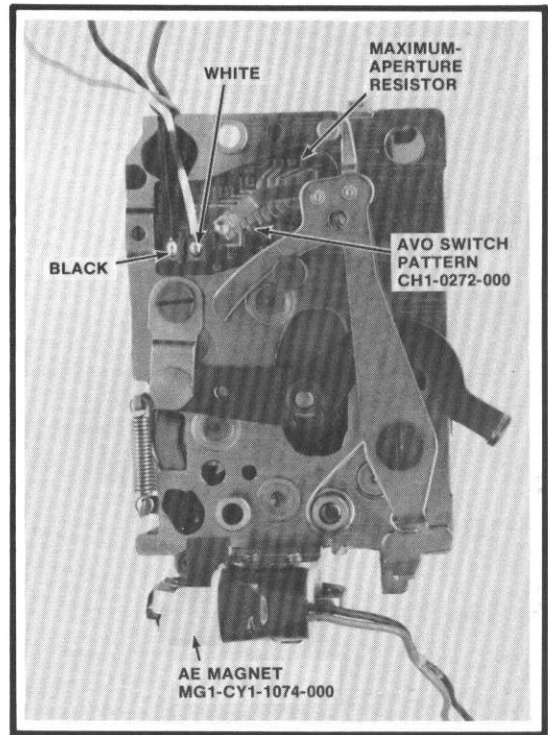

Figure 59

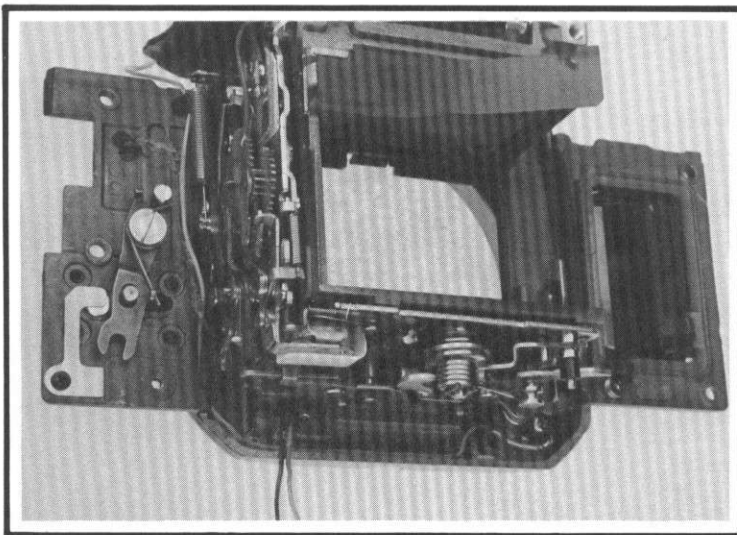

Figure 60

SECTION 9 — REMOVING THE FLEX CIRCUIT

You can remove and replace the flex circuit without taking out the mirror assembly. To remove the flex circuit, proceed as follows:

1. Unsolder the wires from the top of the flex, Fig. 38.
2. Unsolder the MG2 wires from the front of the flex, Fig. 37.
3. Unsolder the MG3 wires from the bottom of the flex, Fig. 61.
4. Unsolder the red positive-battery wire from the SL board, Fig. 62.
5. Remove the film-speed wiper, the battery-test switch, and the screws holding the film-speed base plate.
6. Remove the ground screw and washer at the bottom of the flex, Fig. 61.
7. Unsolder the 4 MD connections at the bottom of the flex, Fig. 61.
8. Unsolder the 2 MG2 connections, Fig. 61, as you lift the bottom section of the flex clear of the camera body.

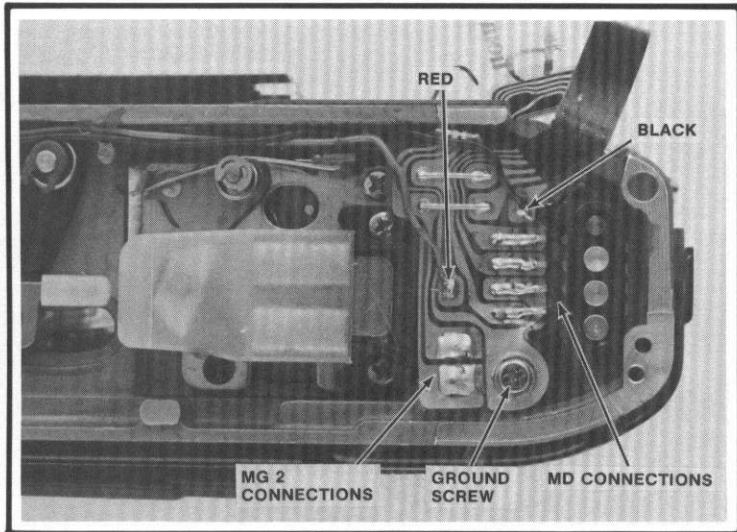

Figure 61

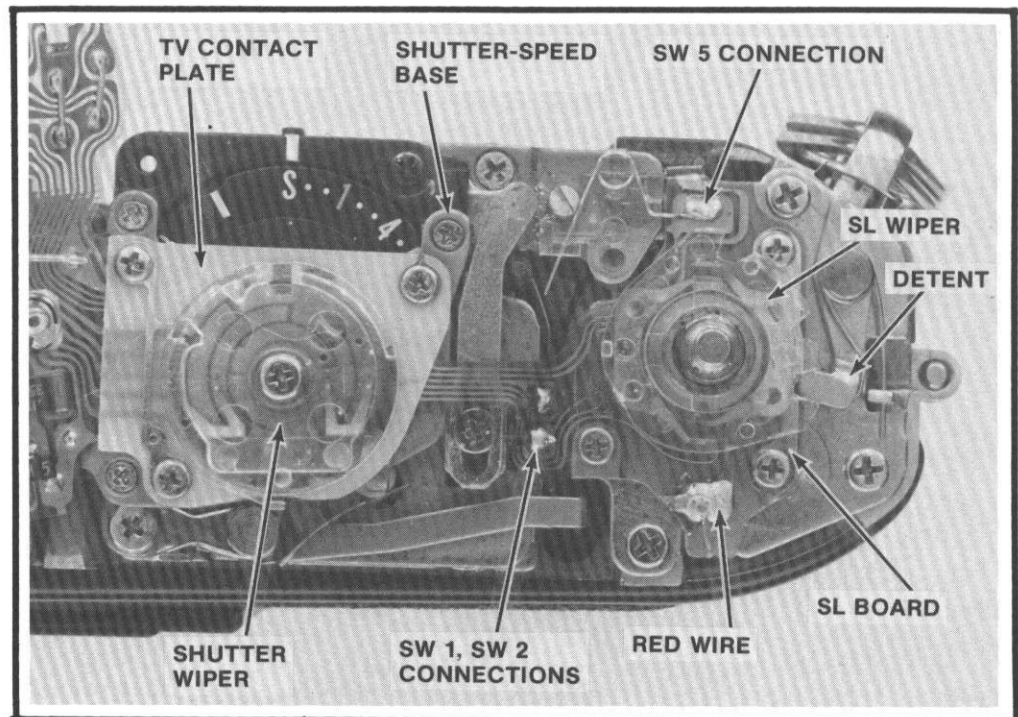

Figure 62

9. Unsolder the SW5 wire contact from the top of the flex, Fig. 62. Remove the SW5 wire contact to prevent loss.
10. Remove the SPD cover, Fig. 20, and lift out the section of flex containing IC4, Fig. 26.
11. Remove the shutter wiper by taking out its center screw, Fig. 62.
12. Remove the 3 screws holding the TV contact plate, Fig. 62.
13. Hold aside the detent, Fig. 62, and lift off the SL wiper.
14. Remove the 3 screws holding the SL board, Fig. 62.
15. Unsolder the SW4 wire contact from the front section of flex, Fig. 63.
16. Unsolder the SW1 and SW2 connections as you lift the SL board, Fig. 62.
17. Remove the complete flex circuit, Fig. 64.

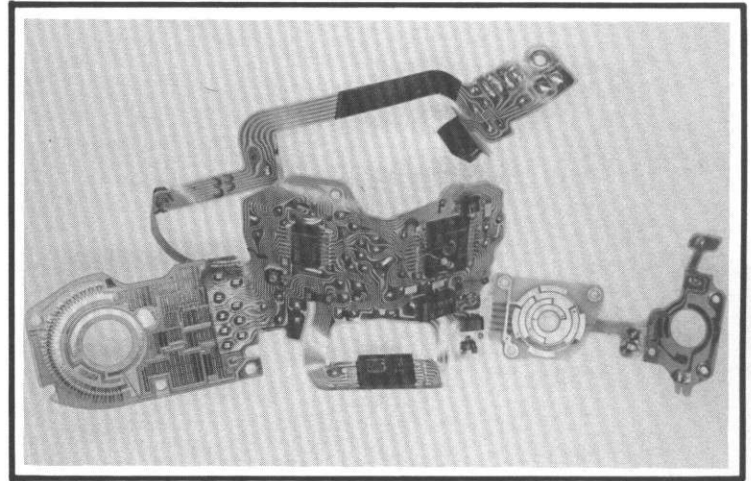

Figure 64 Electric Parts Unit CG1-0124-000

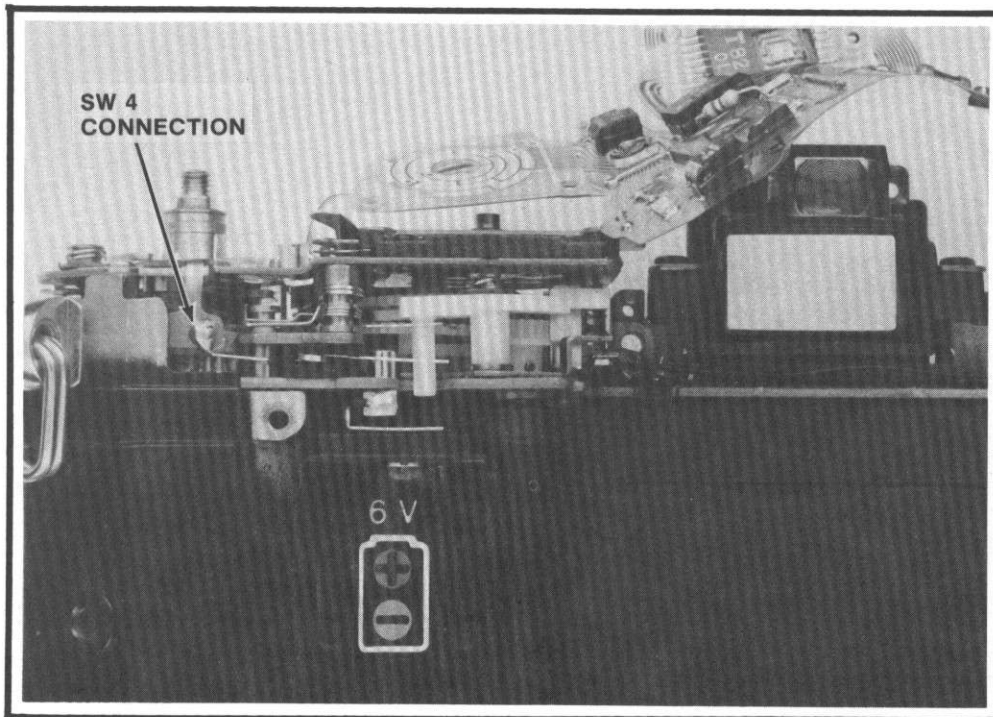

Figure 63

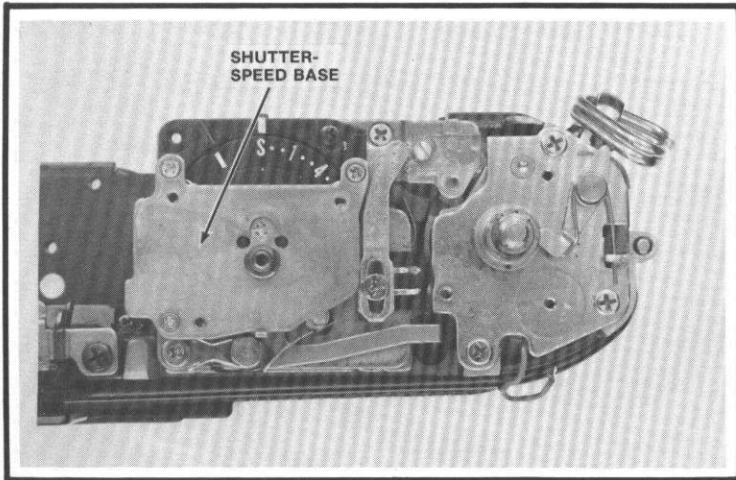

Figure 65

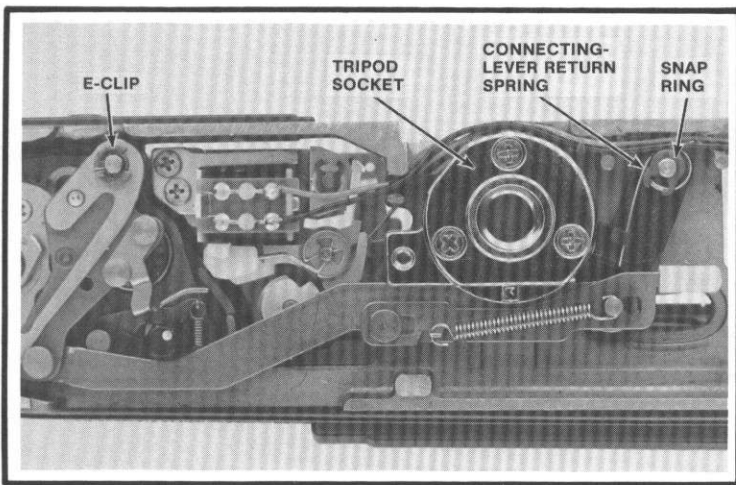

Figure 66

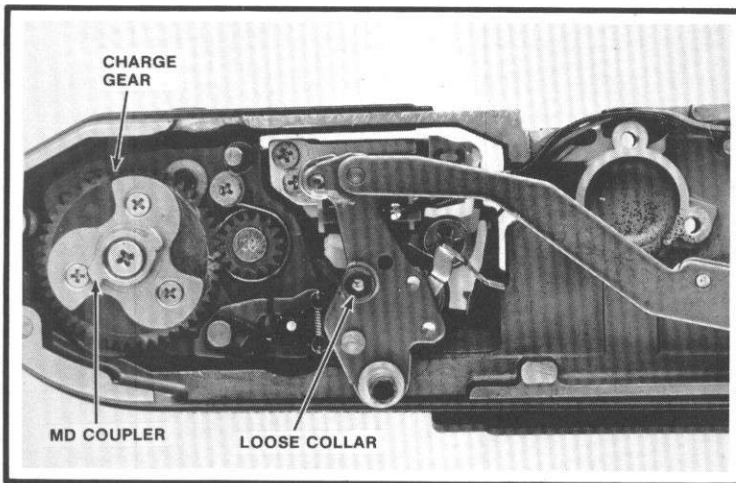

Figure 67

SECTION 10 — REMOVING THE SHUTTER ASSEMBLY

To remove the shutter, first lift aside the top section of the flex circuit. Follow the procedure for removing the flex, but leave the bottom of the flex connected, Fig. 61. Also, you don't have to remove the shutter wiper or the TV contact plate. Rather, take out the three screws holding the shutter-speed base, Fig. 65.

With the mirror assembly removed and the top section of the flex separated from the camera, proceed as follows to remove the shutter:

1. Remove the tripod socket, Fig. 66.
2. Remove the snap ring from the rewind end of the connecting lever, Fig. 66.
3. Disconnect and remove the connecting-lever return spring, Fig. 66.
4. Remove the E-clip from the wind end of the connecting lever, Fig. 66.
5. Lift out the connecting lever.
Caution: Watch for the loose collar on the underside of the connecting lever, Fig. 67. The collar slips over the connecting-lever post and rides against the lobes of the charge cam. You can get the collar in different diameters as an overtravel adjustment for the connecting lever. Although you should never have to make the adjustment, it's necessary to specify the size when ordering a replacement collar. Order collar CA1-4717-000 in one of the following sizes: 3mm (030), 3.2mm (032), 3.3mm (033), 3.4mm (034), 3.5mm (035), 3.6mm (036), 3.7mm (037), 3.8mm (038), or 4mm (040).

6. Remove the screw holding the MD coupler and the charge gear, Fig. 67. You may have to use M.E.K. to loosen the locking agent on the screw threads. Note: The factory uses two slightly different versions of the charge gear as an adjustment; the variation is in the angle of the rectangular center slot with respect to the gear teeth. You should never have to change the charge gear as an adjustment. But, if you have to replace a damaged charge gear, order the same type as the original. You can identify which type the camera uses by the color of the screw, Fig. 67. If the screw is black, replace the charge gear with size 010. If the screw is white (chrome), use charge gear size 050. The part number for the charge gear is CS2-0355-000.

7. Lift off the MD coupler and the charge gear.
8. Remove the 3 screws holding the winding unit, Fig. 68.
9. Lift the winding unit straight up and off the camera body. Be careful that you don't tilt the winding unit as you remove it; tilting the winding unit may dislodge the springs and rollers of the one-way clutch at the top of the wind shaft.
10. Remove the 2 screws holding the counter mechanism, Fig. 68.
11. Lift the counter mechanism off the camera body. The film-counter gear, Fig. 68, remains with the shutter assembly.
12. Push the first-curtain brake lever, Fig. 69, toward the back of the camera. Then lift out the film-counter gear, Fig. 69.
13. Make sure the shutter is in the released position (push the first-curtain latch to release the shutter). Then remove the winding shaft, Fig. 69, by pushing it up from the bottom. Be careful that you don't dislodge the springs and rollers of the one-way clutch.
14. Remove the 2 shutter-retaining screws at the winding-shaft end, Fig. 70.

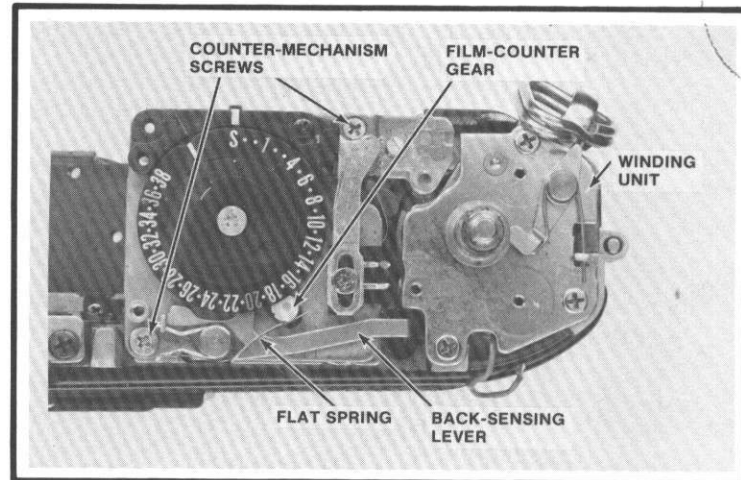

Figure 68

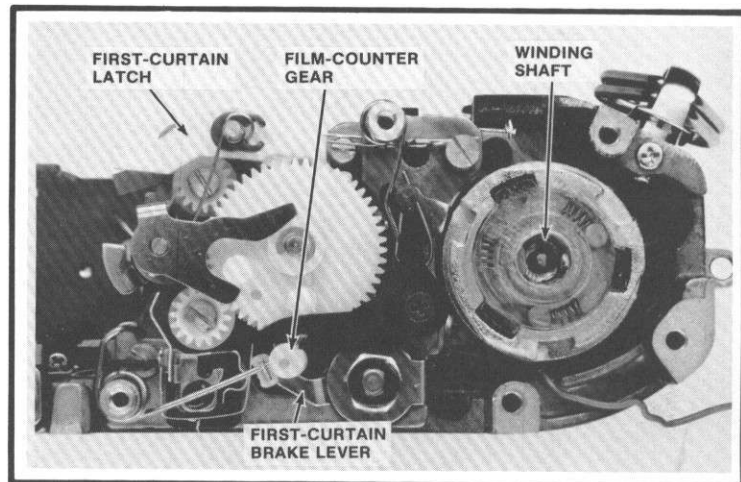

Figure 69

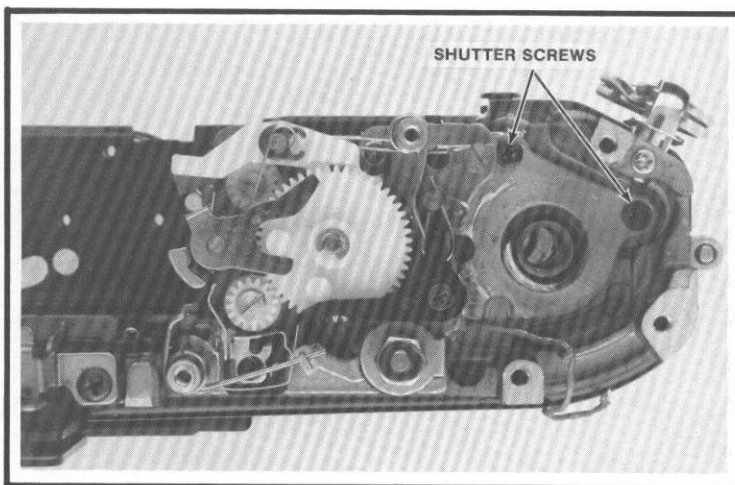

Figure 70

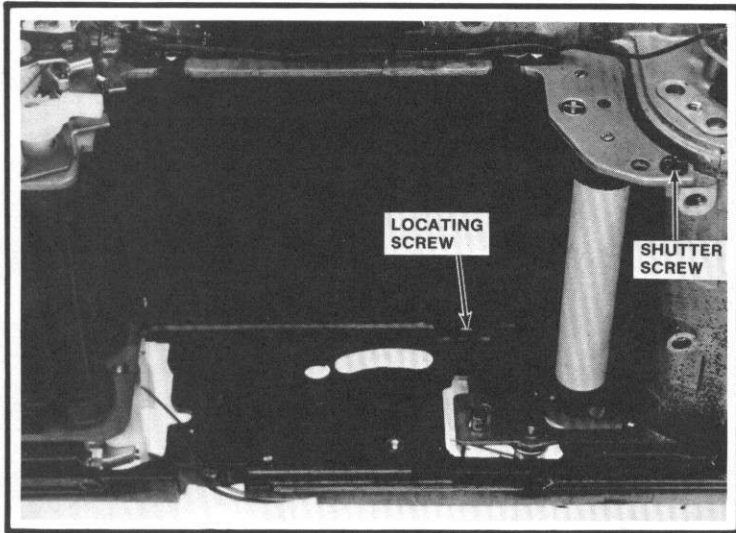

Figure 71

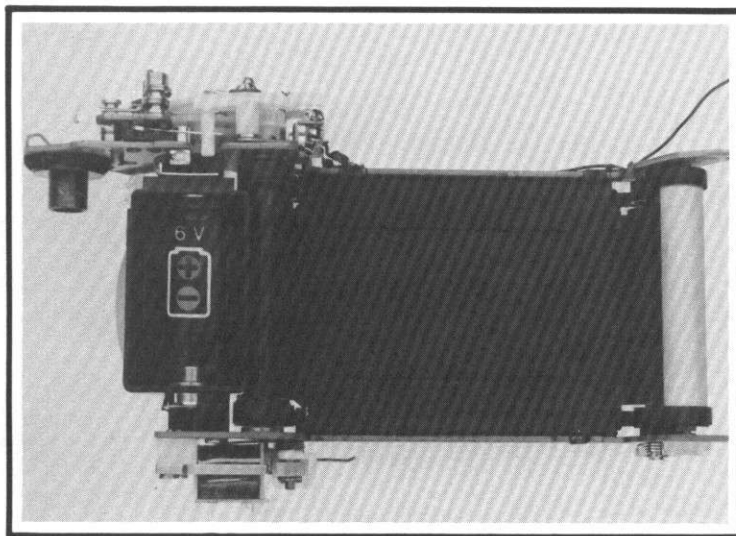

Figure 72 Shutter Unit CG1-0121-000

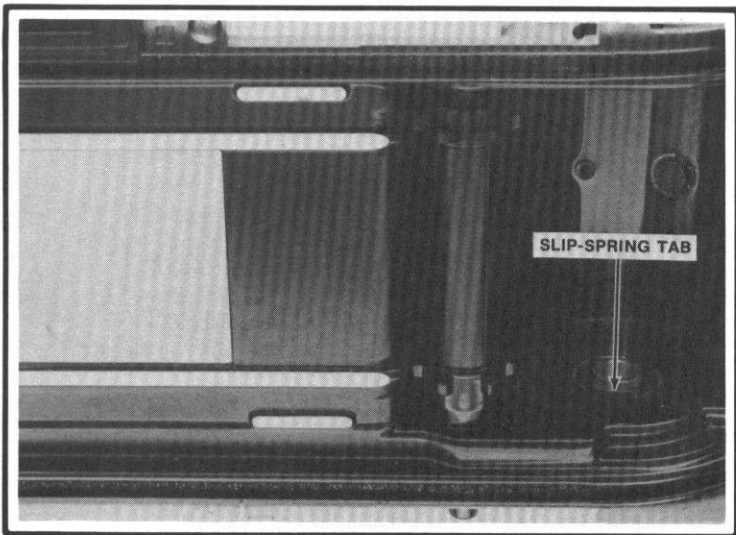

Figure 73

15. Remove the shutter-retaining screw at the tension-rollers end of the shutter, Fig. 71.
16. Remove the locating screw at the bottom of the shutter assembly, Fig. 71.
17. Note that the black X-sync wire routes behind the clips at the top of the shutter. You've already disconnected one end of the black wire (from the P.C. terminal in the top cover); it's not necessary to unsolder the other end of the wire from the X-sync contacts. However, the black wire is cemented to the camera body. Cut the wire loose from the cement as you lift out the shutter. Alternately, you can leave the wire cemented to the camera body and unsolder the end from the X-sync contacts.
18. Using the battery housing as a handle, lift out the shutter assembly, Fig. 72.
19. Lift out the loose take-up spool from the back of the camera body. Watch for the loose endplay spacer in the upper end of the take-up spool.
20. Lift out the loose take-up-spool gear at the bottom of the camera body (from inside the film chamber), Fig. 73.

Replacing the shutter assembly:

1. Seat the take-up-spool gear, Fig. 73.
2. Replace the take-up spool. Make sure the slot in the bottom of the take-up spool fits over the tab on the slip spring, Fig. 73.
3. Route the black X-sync wire under the two lugs at the top of the shutter assembly.
4. Seat the shutter assembly. Replace the locating screw at the bottom of the shutter. Then replace the countersunk screw at the top wind side. Finally replace the remaining two shutter-retaining screws.

5. Lubricate the winding shaft as shown in Fig. 74 with losoid grease.
6. Make sure the shutter is in the released position.
7. Seat the winding shaft with one of its three square lugs passing into the cutaway section of the idler gear, Fig. 74.

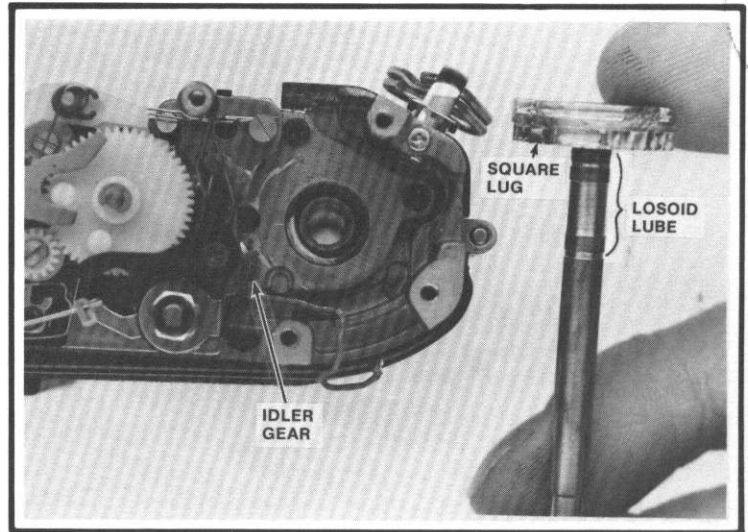

Figure 74

8. If you disassembled the springs and rollers of the one-way clutch, lubricate the rollers with losoid grease before reassembly.
9. Push the first-curtain brake lever toward the back of the camera. Then seat the film-counter gear within its bearing hole as shown in Fig. 75. Note the position of the notch in the top section of the film-counter gear. After you replace the counter mechanism, you may have to reposition the film-counter gear to time the notch to the counter teeth. Push the first-curtain brake lever toward the shutter to hold the film-counter gear in place.

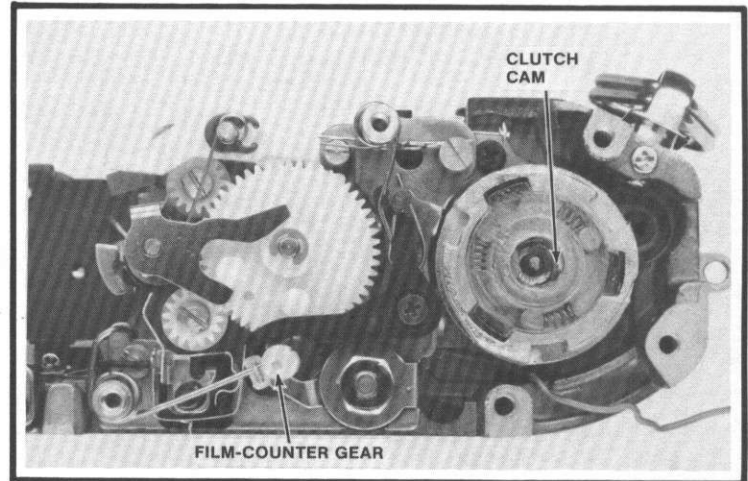

Figure 75

10. Check the position of the clutch cam in the center of the one-way clutch, Fig. 75. The flat sides of the hole in the center of the clutch cam should be parallel with the ends of the camera body; the clutch cam is then in the proper position to receive the shaft of the winding unit, Fig. 76. If necessary, you can turn the clutch cam in a clockwise direction. Hold down the retaining plate at the top of the one-way clutch to prevent the springs and rollers from dislodging.

11. Replace the winding unit and the counter mechanism, Fig. 68. Note in Fig. 68 that the upper end of the film-counter gear fits between the counter dial and the flat spring. The flat spring pushes the film-counter gear into engagement with the counter dial when you close the camera back.

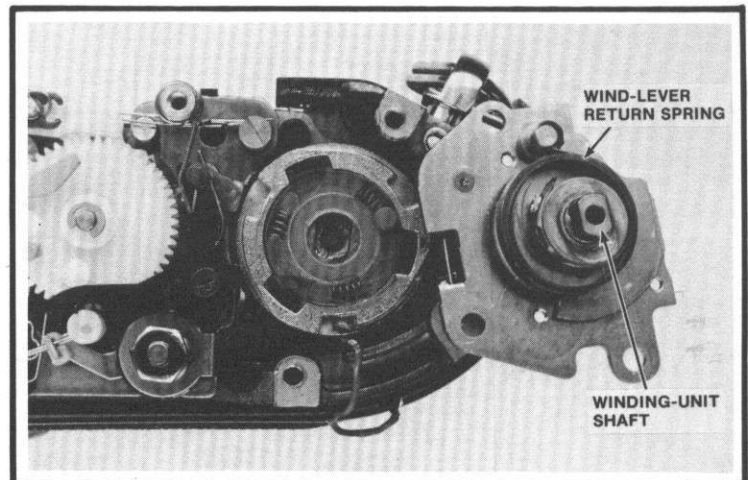

Figure 76

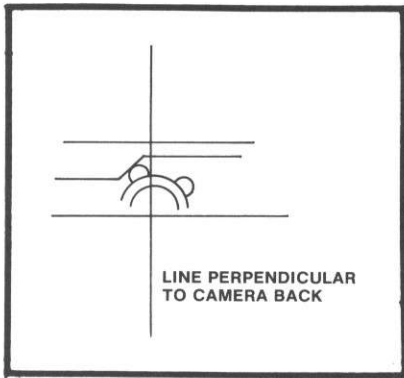

Figure 77

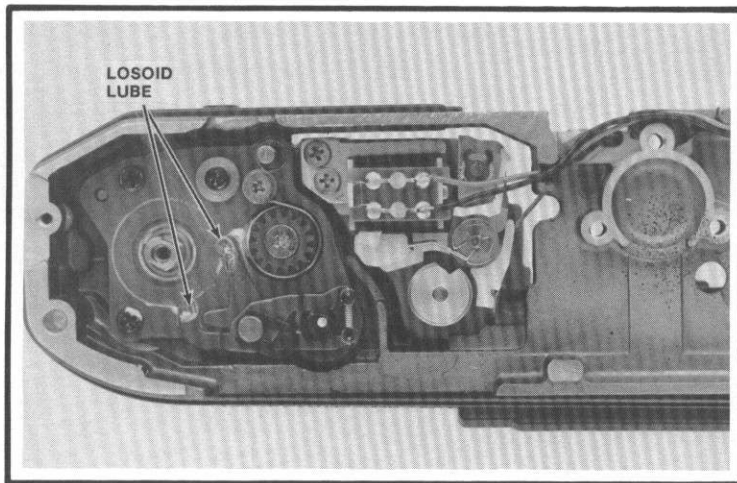

Figure 78

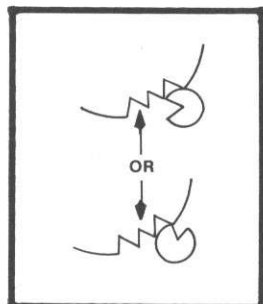

Figure 79

12. Turn the sprocket to the timed position, Fig. 77.
13. Lubricate the ends of the rewind latches, Fig. 78, with losoid grease.
14. Seat the charge gear on the lower end of the winding shaft—a space between two lobes on the charge cam should point to the center of the camera. Push the rewind latches against their spring tensions to fully seat the charge gear.
15. Seat the MD coupler.
16. Use a locking agent such as Loctite on the threads of the charge-gear screw. Replace the screw.
17. Lubricate the collar post on the underside of the connecting lever with losoid grease. Also lubricate the charge-cam lobes with losoid grease.
18. Seat the collar on the connecting-lever post.
19. Replace the connecting lever and the connecting-lever spring.
20. Replace the tripod socket.
21. Temporarily replace the winding seat and the wind lever to check the timing of the film-counter gear. Cock and release the shutter three times (you can release the shutter by pushing the first-curtain latch). The notch in the top section of the film-counter gear should now be positioned as shown in Fig. 79 with respect to the teeth of the counter. If necessary, you can change the timing between the film-counter gear and the pinion on top of the sprocket. Push the first-curtain brake lever toward the back of the camera. Then lift the film-counter gear high enough to disengage it from the pinion. Be careful that you don't grasp the top surface of the film-counter gear with your tweezers. If you scratch the top surface, the counter dial may advance twice for each wind-lever stroke. Rather, grasp the film-counter gear by the thin portion of its shaft.

SECTION 11 — SHUTTER OPERATION

To cock the shutter, you can use your thumb to rotate the first-curtain roller, Fig. 80. Turning the first-curtain roller draws both curtains to the cocked position. The curtains should overlap by one bar width (1.5-3.0mm).

The curtains remain in the cocked position when the first curtain latch engages the first-curtain gear, Fig. 81. If you now push in the first-curtain latch, both curtains will cross the aperture together. You can release the curtains individually by holding the MG3 armature engaged with the second-curtain cam.

Now release the first curtain by pushing in the first-curtain latch. The second curtain remains held for as long as you keep the MG3 armature engaged. By looking at the back of the shutter, you can check the timing of the second curtain—the second-curtain bar should be aligned behind the two punch marks on the aperture plate.

Although the shutter is basically the same as the AE-1 shutter, it uses Delrin gears. It's possible to force the second-curtain gear out of time if the shutter jams. Rather than breaking, the flexible Delrin gear may jump teeth. The shutter then loses the timing between the second-curtain gear and the roller pinion, Fig. 81.

You can often retime the shutter without taking it apart. By flexing the second-curtain gear, you can disengage the gear teeth. You can then change the timing between the second-curtain gear and the roller pinion. Adjust the timing so that the second-curtain bar aligns behind the punch marks when the MG3 armature is engaged with the second-curtain cam.

If the shutter does have broken or damaged parts, you have a choice in the repair—you can replace individual parts or you can replace the complete shutter assembly (shutter unit CG1-0121-000). The shutter assembly comes complete as shown in Fig. 80. However, the red insulator that closes switch SW5, Fig. 81, isn't part of the shutter assembly. Transfer the insulator from the old shutter to the new shutter.

The shutter operation, disassembly, and timing are the same as in the AE-1. But the AE-1 Program shutter has faster travel times because of the Delrin gears. As the second-curtain gear, Fig. 81, rotates clockwise, its post moves away from the SW5-control lever. The transport latch, Fig. 81, can then move against the transport cam at the top of the wind shaft.

At the end of the cocking cycle, the transport latch drops into a notch in the transport cam. Now the insulated post on the transport latch opens SW5.

Releasing the shutter allows the first-curtain gear to rotate counterclockwise as the first curtain crosses the aperture. The first-curtain gear strikes the first-curtain brake lever just before the curtain bar completely clears the aperture. The first-curtain brake lever closes the X-sync contact, Fig. 81.

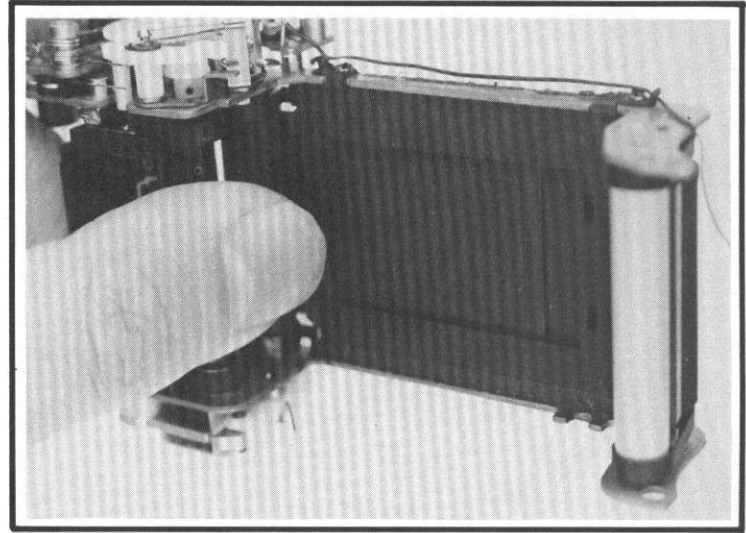

Figure 80

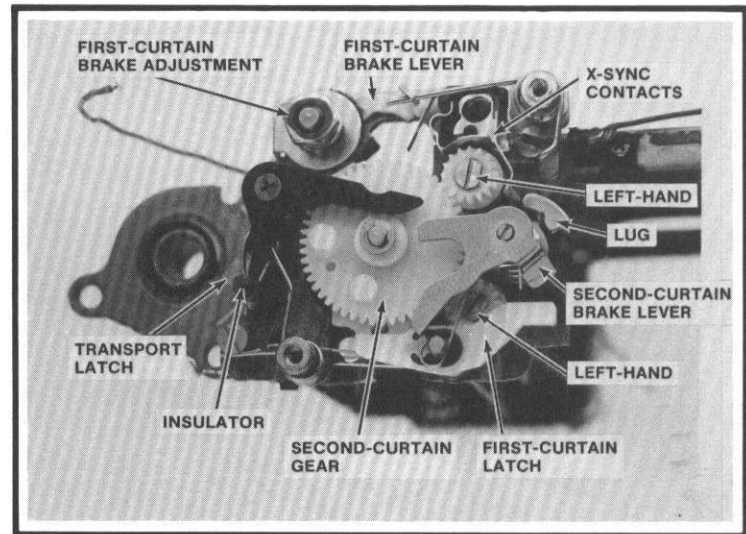

Figure 81

The nut on top of the first-curtain brake lever controls the brake-spring pressure. By turning down the nut, you can increase the braking action. After you've reassembled the camera, check for curtain bounce at 1/60. You can reach the first-curtain brake adjustment from the back of the camera.

Adjusting the first-curtain brake normally corrects for both first-curtain bounce and second-curtain bounce. But the second curtain does have its own brake, Fig. 81. The post on top of the second-curtain gear strikes the second-curtain brake lever as the second curtain nears the end of the aperture. Now the second-curtain gear drives the second-curtain lever in a clockwise direction, Fig. 81. The lug on the second-curtain brake lever strikes the mirror-return lever to return the mirror.

It's usually not necessary to adjust the spring pressure on the second-curtain brake, Fig. 81. Excessive brake pressure could cause a failure of the mirror to return.

If you do disassemble the shutter, be careful of the screws holding the winding-rollers pinions, Fig. 81—the screws have left-hand threads. Also, the screws simply clamp the pinions to the tops of the winding rollers. It's then possible to adjust curtain timing without disengaging the gears. Just loosen the screws holding the pinions and move the curtains to the timed positions.

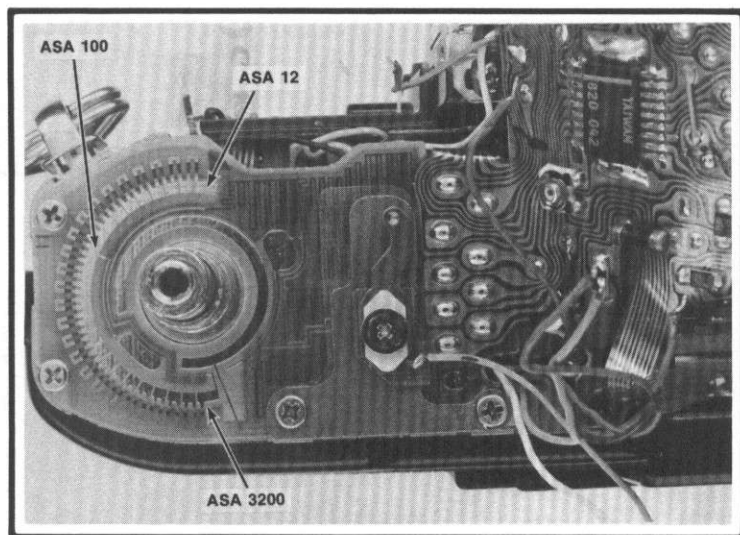

Figure 82

SECTION 12 — EXPOSURE ADJUSTMENTS

Unless you've replaced circuit components, you should only have to adjust the manual speeds and the auto exposures. Refer to Section 13 if you have replaced circuit components.

Make the exposure adjustments with the camera completely assembled except for the cover plates. When you replace the film-speed wiper, set the brush (under the coupling pin) on the ASA 100 land, Fig. 82.

Sequence:

1. Turn the shutter brush to the 1/1000 position (one position clockwise from the program setting).
2. Check and adjust the curtain travel times (10.5ms for a 34mm distance).
3. Check the shutter speed at the 1/1000 setting. Adjust with variable resistor VR2, Fig. 83. If VR2 won't bring in 1/1000, you can bend the count switch SW4. Bending the tip of the wire contact closer to the first-curtain latch causes SW4 to open sooner — a faster speed at 1/1000.

4. Check the other manual speeds by turning the shutter brush clockwise. If the slower speeds aren't accurate, you may have to adjust the oscillator (clock) frequency. See Section 13.
5. Set the shutter wiper to program and install the lens. Set the lens to the auto-diaphragm position.
6. Make sure the film-speed wiper is at ASA 100. If your test instrument has a K-factor control, set 12.50. Check the auto exposure with a dummy top cover installed or while shielding the top of the camera from ambient light.
7. Adjust VR1 for an accurate auto exposure. VR1 provides a level control; the effect is the same at all light levels. You might make the adjustment at EV 12 and then check the auto exposure at other light levels—EV 9 through EV 15. The auto exposure should remain within 0.5 EV at all light levels.
8. If the auto exposures don't remain within 0.5 EV, it's necessary to adjust the gain by changing the fixed resistor R7, Fig. 83. Remove R7 from the flex board. Then install a 10K variable resistor in place of R7. Adjust the variable resistor until the exposure error at EV 9 is the same as the exposure error at EV 15. Use VR1 to correct the error at EV 12. Remove the 10K variable resistor and measure its value. Install a fixed R7 resistor that matches the value as closely as possible.

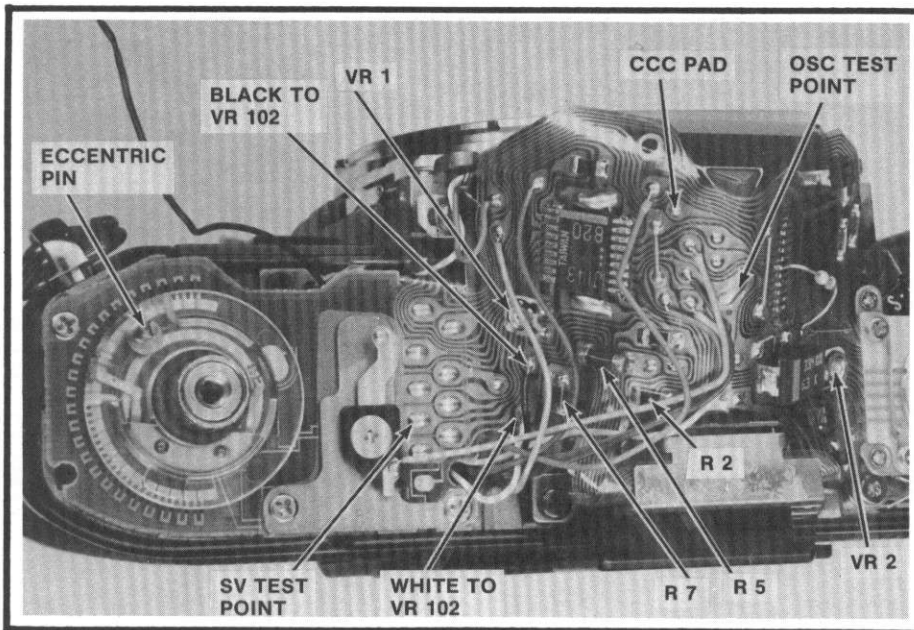

Figure 83

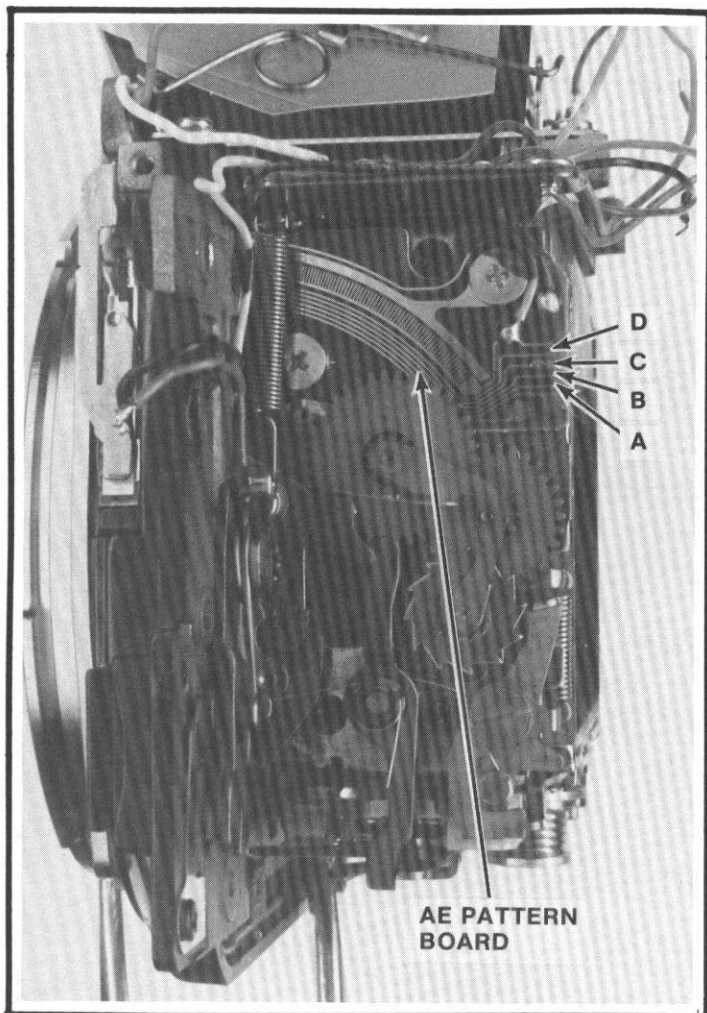

Figure 84

SECTION 13 — ADJUSTMENTS NOT NORMALLY REQUIRED

1. Auto Aperture

Adjusting the size of the automatically controlled diaphragm setting should not be necessary unless you've replaced the AE pattern board on the mirror housing, Fig. 84. To check, connect a 4.7K resistor between ground and the CCC pad on the flex, Fig. 83. The lens should now program the f/4 aperture.

Verify by releasing the shutter on auto (program or shutter-speed preferred). Then turn the diaphragm-setting ring off the auto position to f/16. Push in the stop-down lever to stop down the lens; the diaphragm should close to f/4.

You can check the actual aperture size by slowly turning the diaphragm-setting ring toward the larger apertures—note when the diaphragm leaves start to open. The diaphragm leaves should start to open when the diaphragm-setting ring reaches the f/4 setting. Alternately, you can measure the light transmission at auto with the 4.7K resistor connected.

The adjustment for the aperture size is bridging lands on the LED display board, Fig. 85, or by breaking connections on the AE pattern board, Fig. 84. Bridging lands on the LED display board affects both the LED readout and the diaphragm setting. Breaking connections on the AE pattern board, Fig. 84, affects the diaphragm setting without changing the LED readout.

a. 1/8 stop underexposure

Increase the aperture size 1/8 stop by connecting the A1 land to the land directly above it, Fig. 85 with a solder bridge, Fig. 86.

You can reach the lands from the front of the camera—it's not necessary to lift aside the film-speed base plate.

b. 1/4 stop underexposure

Increase the aperture size 1/4 stop by connecting both the A1 land and the A2 land to their adjacent lands, Fig. 86, with solder bridges.

c. 1/8 stop overexposure

Decrease the aperture size 1/8 stop by connecting the A2 land to the land directly above it with a solder bridge, Fig. 86.

The following adjustments on the AE pattern board affect only the diaphragm size. Remove the mirror assembly to reach the connections by the S.AVE contact, Fig. 84.

- d. 1/8 stop overexposure
Cut the land of the AE pattern board at A, Fig. 84, to reduce the aperture size 1/8 stop.
- e. 1/4 stop overexposure
Cut the land of the AE pattern board at B, Fig. 84, to reduce the aperture size 1/4 stop.
- f. 3/8 stop overexposure
Cut the land of the AE pattern board at C, Fig. 84, to reduce the aperture size 3/8 stop.
- g. 1/2 stop overexposure
Cut the land of the AE pattern board at D, Fig. 84, to reduce the aperture size 1/2 stop.

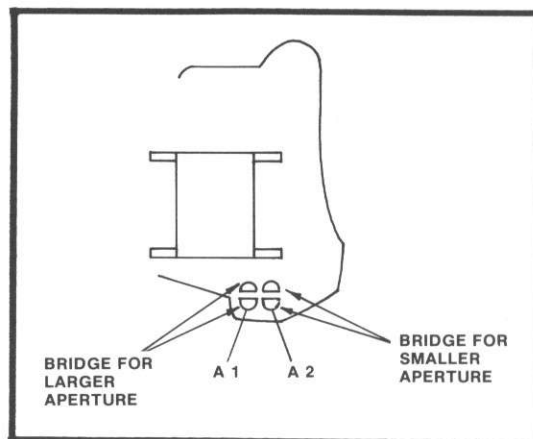

Figure 86

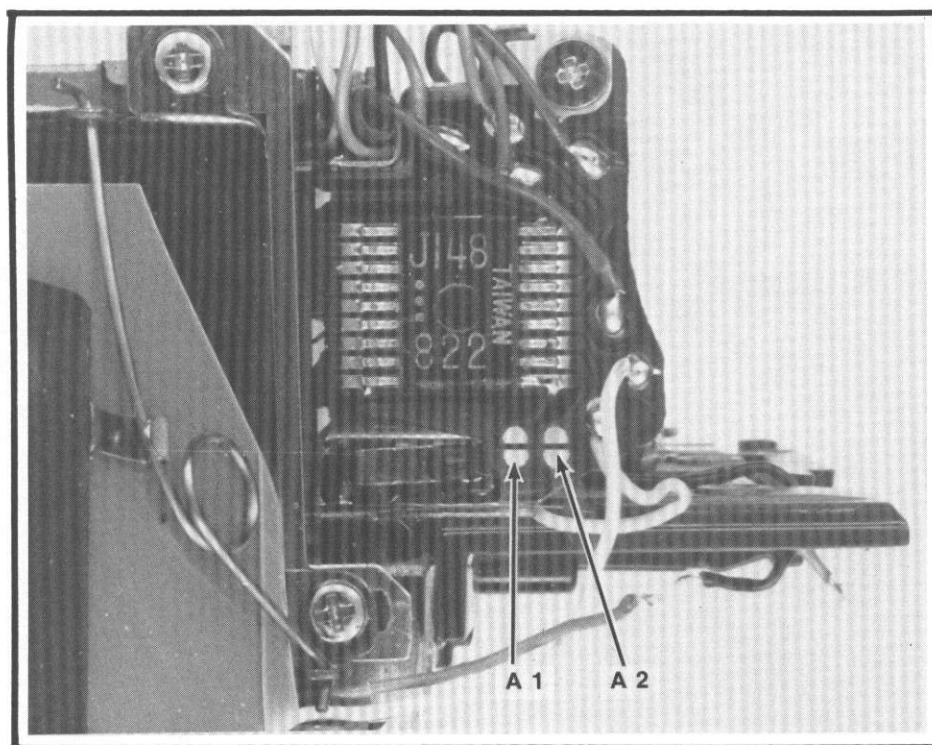

Figure 85

2. Oscillator (clock) frequency

Adjusting the oscillator frequency should not be necessary unless you replace IC1. To check, connect an oscilloscope or a frequency counter between the OSC test point, Fig. 83, and ground. When you close SW1, you should measure the 32KHz clock signal (tolerance—30,117-34,134 Hz).

If you don't have an oscilloscope or a frequency counter, you can check the frequency by measuring the slow shutter speeds or the self-timer delay. Check the shutter speed at 1/2 second. If the exposure time is 476 to 525ms, the clock frequency is correct. You can more accurately check the frequency by measuring the self-timer delay (because the counter must count more pulses). Adjust the oscillator for a delay of 10 seconds.

Make the frequency adjustment by removing fixed resistor R2, Fig. 83, and connecting a 200K variable resistor in its place. Adjust the variable resistor for the proper frequency (reducing the resistance increases the frequency). Then remove the variable resistor and install a fixed resistor of the same value.

3. Offset

Check the offset adjustment if you replace IC4. Unsolder one end of resistor R5, Fig. 83. Now short pin 11 of IC4 to pin 9 (output shorted to input), Fig. 87. Make two voltage readings with SW1 closed:

- a. Measure the voltage between pin 10 of IC4 and ground.
- b. Measure the voltage between pin 11 of IC4 and ground.

Voltage reading b, Fig. 87, should be the same as (or not more than 5mv less than) voltage reading a. To adjust, remove the offset resistors R3 and R4, Fig. 88. The camera may have only one offset resistor in the circuit. You may also find that both offset positions are open.

Now install a 200K variable resistor in the R4 position, Fig. 88. Adjust the variable resistor until the b voltage, Fig. 87, is the same as the a voltage. Then install a fixed resistor in place of the variable resistor. If you can't bring in the offset adjustment at the R4 position, use the R3 position, Fig. 88.

4. Maximum-aperture correction pin

Check the adjustment if you replace the maximum-aperture resistor VR102. You can

check the adjustment before you replace the mirror assembly. The adjustment affects the actual resistance reading with the maximum-aperture correction pin depressed specific amounts. To make the adjustment, change the effective length of the maximum-aperture correction pin. First use M.E.K. to loosen the adhesive holding the setscrew in the center of the maximum-aperture correction pin. Then turn the setscrew.

Check the adjustment as follows:

- a. Measure the resistance of R108 between the black wire and the white wire of the maximum aperture resistor. The standard value is 1.5K.
- b. If R108 measures 1.5K, depress the maximum-aperture correction pin a distance of 8.10mm (measured from the front surface of the lens-mounting ring to the top surface of the maximum-aperture correction pin). You can use a depth micrometer or the standard 1.4 lens. Now measure the resistance between the white wire and ground. You should measure 9.32K.
- c. Next depress the maximum-aperture correction pin 5.7mm. The resistance between the white wire and ground should be 4.16K.
- d. Adjust the maximum-aperture correction pin so that the resistance readings at the two settings are within 5% of the specifications.
- e. If the resistance of R108 is some value other than 1.5K, the resistance readings between the white wire and ground won't match the specifications. You can then calculate a correction factor to find the proper resistance values. Divide the actual resistance measured between the white wire and the black wire by 1.5K to determine the correction factor. For example, suppose that you measure 1.45K across R108. The correction factor is then 0.966.
- f. You can now use the correction factor to determine the proper resistance values between the white wire and ground. With the maximum-aperture correction pin depressed 8.10mm, the resistance between the white wire and ground should be 9.32K times the correction factor. So, with a correction factor of 0.966, the actual resistance reading should be $0.966 \times 9.32\text{K} = 9.003\text{K}$.

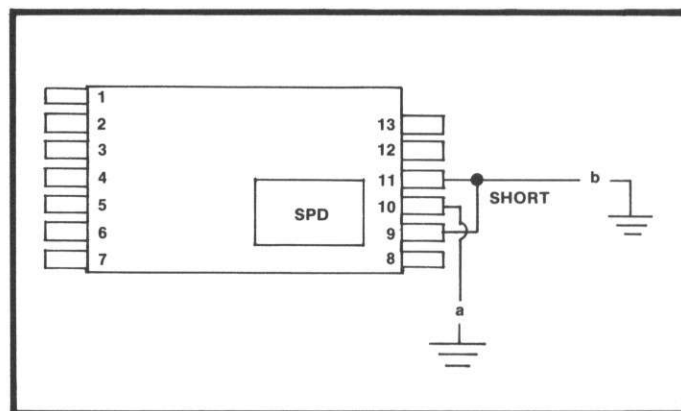

Figure 87

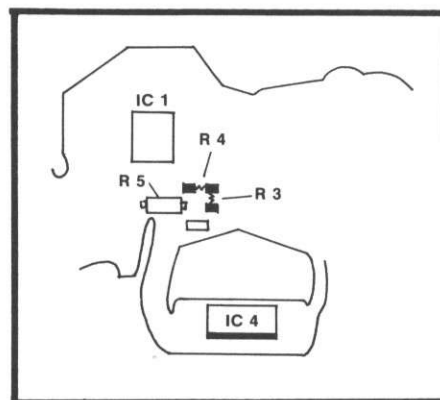

Figure 88

5. Film-speed wiper

Turning the eccentric pin on the film-speed wiper, Fig. 83, matches the brush position to the ASA calibrations. The adjustment should not be necessary unless you replace the film-speed wiper or the top cover.

To check the adjustment, solder a wire to the SV test point, Fig. 83. Solder another wire to ground (the ground tab of IC1 makes a good ground connection). Measure the resistance between the two wires—you should measure between 2.5K and 4.5K, depending on the position of the film-speed wiper.

Now turn the film-speed wiper until the brush near the eccentric pin is on the ASA 3200 contact, Fig. 82. Record your resistance reading. Next turn the film-speed wiper until the brush is on the ASA 12 contact, Fig. 82. Again record your resistance reading. You now know what resistance readings you should get at the two extreme positions of the film-speed wiper.

You can then check to see if the film-speed dial moves the film-speed wiper to the proper positions. Replace the top cover, allowing the test leads to pass under the top cover to the back of the camera. Also reassemble the film-speed dial.

Set the film-speed dial to ASA 3200. Your resistance reading between the test leads should match the resistance you recorded earlier for ASA 3200. Also check to see if the ASA 12 resistance reading matches your recorded reading. If the resistance readings don't match, adjust the eccentric pin on the film-speed wiper.

The brush on the film-speed wiper should be sitting on the center of its contact. If not, you may be able to shift the brush off the contact with the play in the film-speed dial. Set the film speed dial to ASA 100 and note the resistance reading. Now, with the film-speed dial latched at ASA 100, take up the play in both directions—just rotate the film-speed dial without disengaging the lock. The resistance reading should not change. If it does, the brush is moving off its contact. Turn the eccentric pin slightly and repeat the test.

SECTION 14 — TROUBLESHOOTING GUIDE

Symptom: shutter won't release, no LED's turn on in finder
 Check first: battery defective, ground screw loose at bottom of flex

Test Sequence:

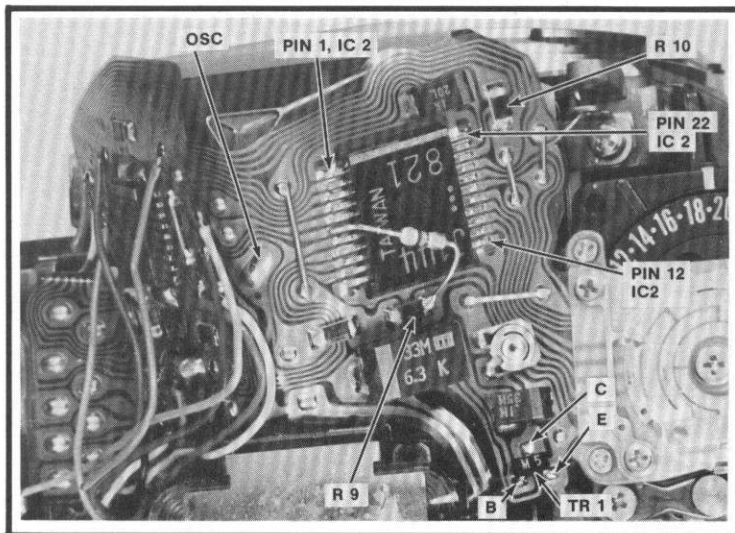
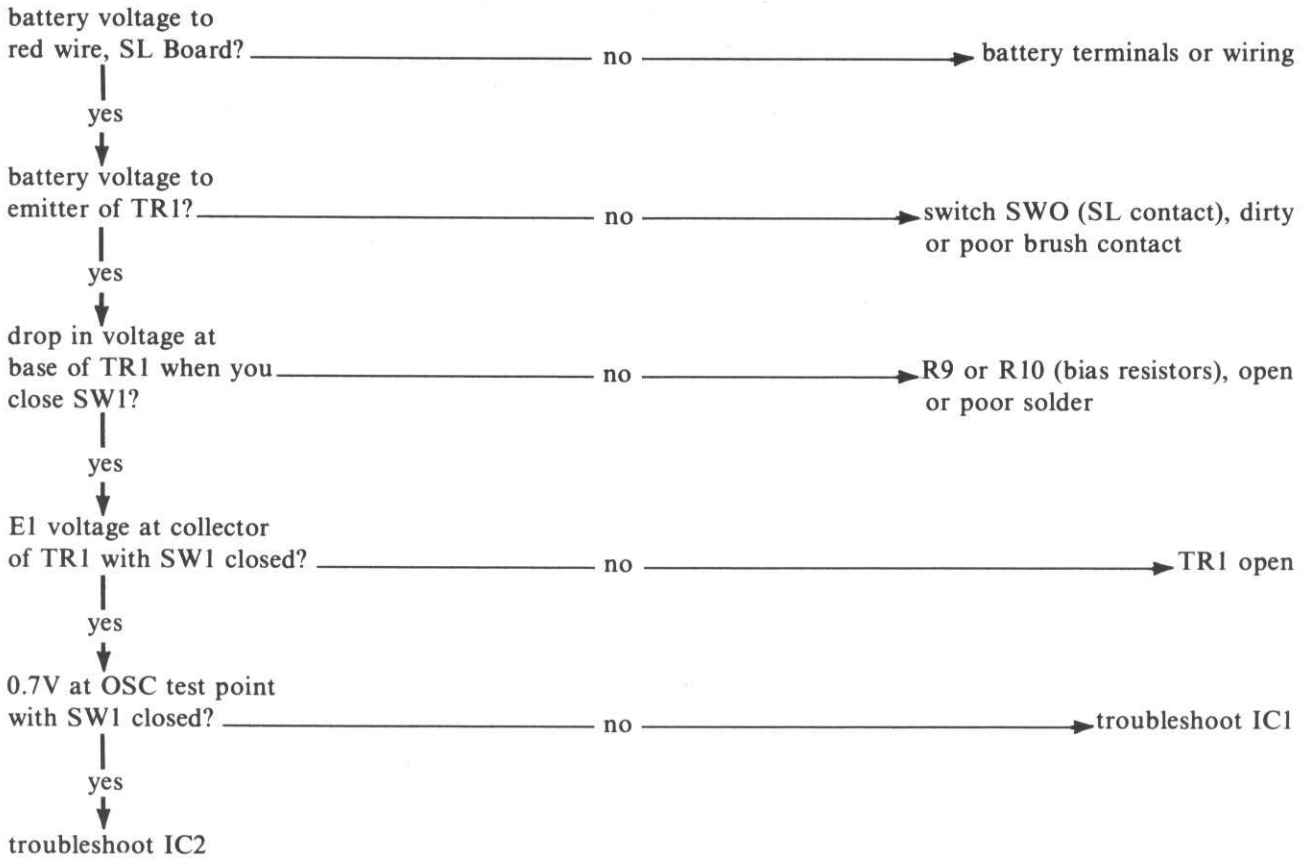

Figure 89

Symptom: Shutter will not release, LED's do turn on in finder

Check

Procedure

MG2

Close SW1 and short between ground and the MG2 signal lead, Fig. 90. The shutter should release. If it doesn't, check MG2 for an open coil or dirty armature/core interface. Coil resistance (measured between two MG2 connections at bottom of flex): 90 Ω

Continuity, MG2 to IC1

Close SW1 and short pin 19 of IC1 to ground. The shutter should release. If not, retouch the solder at pin 19. Check for an open between pin 19 and MG2.

MG3

Check the voltage at each lead of MG3 with SW1 closed. If you measure E1 at the red wire and 0V at the black wire, MG3 has an open coil. MG3 coil resistance: 200 Ω

MG1

Check for E1 at each lead of MG1, Fig. 37, with SW1 closed. If you measure E1 at the red wire and 0V at the black wire, MG1 has an open coil. MG1 coil resistance: 330 Ω

SW5

Check to see if SW5 fails to open or is shorted to ground. If SW5 fails to open at the end of the cocking stroke, adjust the eccentric (see Section 3). If SW5 shorts to ground with the shutter cocked, check to see if the red insulator has come off the transporter latch.

SW4

Poor switch contact in SW4 causes a failure of the shutter to release. Try shorting the wire contact of SW4 to ground. If you can then release the shutter, the problem is poor switch contact. Clean SW4.

IC2

Check the solder connections at pins 17, 18, and 19

IC1

Check the voltage at pin 7 of IC2. The voltage should drop to 0V when you close SW2. If it does, troubleshoot IC1. If it doesn't troubleshoot IC2.

SW2

Close SW1 and short pin 17 of IC2 to ground. The shutter should release and time out. If it does, IC1 and IC2 are o.k. Check for poor solder between SW2 and the flex or an open between the SW2 solder connection and pin 17 of IC2.

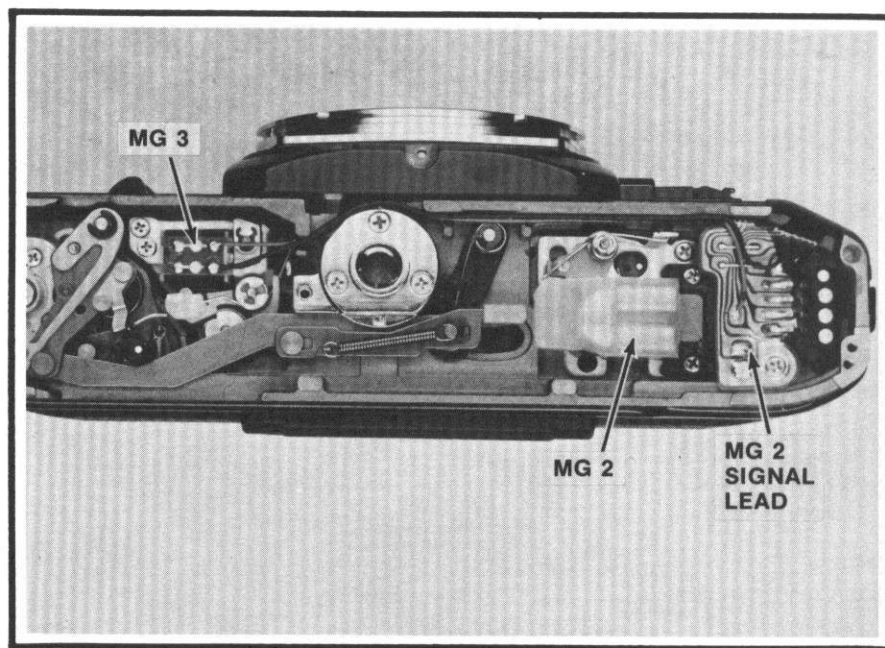

Figure 90

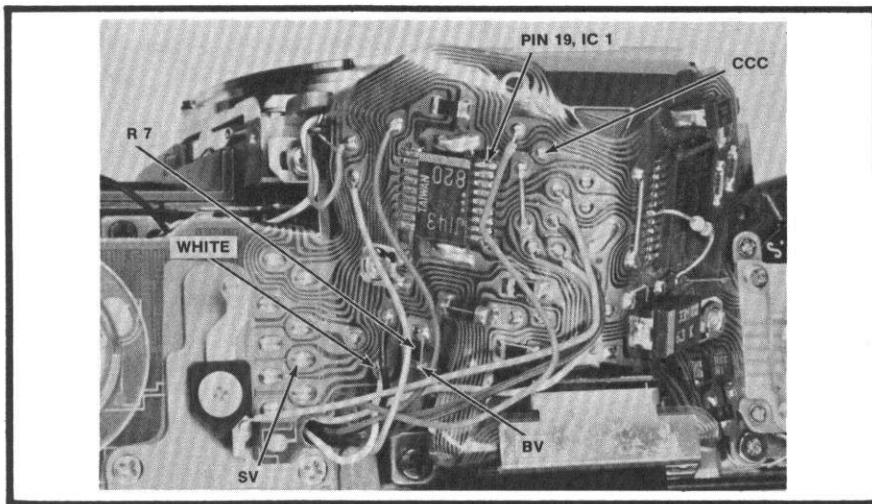

Figure 91

Symptom: f/stop LED indication in finder does not change with changes in light level or film speed.

Check

Procedure

IC4

Check the BV signal at pin 4 of IC4 or at R7, Fig. 91. With SW1 closed, you should get a change in voltage as you change the light level striking the SPD. The BV voltage should go more positive as you decrease the light level. If there's no change, troubleshoot IC4.

IC2

Connect a 4.7K resistor between the CCC land, Fig. 91, and ground. The LED readout should change to f/4. If it does, IC2 is o.k.

IC1

Check for the K_{Vc} voltage at pin 9 and the V_c voltage at pin 11. If you get the V_c voltage, but not the K_{Vc} voltage, replace IC1. If you get both voltages, troubleshoot IC1 at pin 5 (see Section 15).

Film-speed contact

Measure the resistance between ground and the SV test point, Fig. 90. The resistance should vary between 2.5K and 4.5K as you turn the film-speed contact.

- Symptom: shutter delivers only 2-second exposure (but stays open as long as you hold down release button), no "P" LED in finder
Cause: The problem may have been caused by an off-brand flash unit with a high voltage trigger damaging IC2. Check the voltage at pin 12 of IC2 with the shutter wiper at the program setting. You should measure around 1.6V. If you measure 0V, replace IC2.
- Symptom: shutter releases when you close SW1 or the battery-test switch
Cause: IC2 defective
- Symptom: battery-test signal is a continuous tone rather than a beep
Cause: IC2 defective
- Symptom: camera delivers auto f/stops even with the lens set to manual f/stops
Cause: poor contact in auto-manual switch SW11 or IC2 defective. Check SW11 between the yellow wire at the LED display board and ground. You should measure no resistance with the lens set to auto.
- Symptom: viewfinder LEDs won't display an aperture larger than f/5.6, regardless of the maximum aperture of the lens installed
Cause: check the maximum-aperture resistor. Disconnect the white wire, Fig. 91 from the flex and measure the resistance between the white wire and ground. As you push in the maximum-aperture correction pin, the resistance should go from around 4K to around 11K. If the maximum-aperture resistor checks o.k., measure the voltage at pin 2 of IC4. The voltage should go from around 1.8V to around 1.4V as you push in the maximum-aperture correction pin. If the voltage remains at 1.8V, replace IC4.
- Symptom: 1/1000 slow or erratic
Check: MG3 for dirt or oil contamination. Clean the core/armature interface.
- Symptom: auto diaphragm opening too small (underexposure) or erratic
Check: MG2 (armature/core interface) and the S.AVE contact for dirt or oil contamination
-

SECTION 15 — TESTING THE IC'S

For some of the IC tests, it's desirable to have an oscilloscope. However, you can make most of the tests with voltage measurements at the pins. Refer to Section 17 for IC pin numbering. You may wish to remove the page showing the IC you're troubleshooting. Make all voltage measurements to ground with SW1 closed.

ICI

1. Check for the input E1 voltage at pin 17. No voltage—check the continuity between pin 17 and the collector of TR1.

2. Check for input V_c voltage at pin 11; you should measure 1.3V. No voltage—check IC4. Also check the continuity between pin 11 of IC1 and pin 7 of IC4.
3. Check for the KV_c voltage at pin 9; you should measure around 1.6V. No voltage—replace IC1.
4. Check the metering input at pin 6. The voltage should change as you change the light striking the SPD. No change—check IC4.
5. To check the output metering voltage pin 5, you need an oscilloscope; you'll measure 0V with a voltmeter. With an oscilloscope, you should see a change in the output waveform as you change the light level or film speed. No change—replace IC1.
6. Check the oscillator at pin 13 or at the OSC test point. No signal—check the R2 solder connections before replacing IC1. You can check the oscillator with a voltmeter. A voltage of 0.7V at pin 13 indicates that the oscillator (clock) signal is present.

IC2

1. Check for the input $E1$ voltage at pin 3. No voltage—check the continuity between pin 3 and the collector of TR1.
2. Check the input V_c voltage at pin 9; you should measure 1.3V. No voltage—check IC4 and check for continuity between pin 9 of IC2 and pin 7 of IC4.
3. Check for the input oscillator signal at pin 8. No signal—check IC1 and check for continuity between pin 8 of IC2 and pin 13 of IC1. A voltage of 0.7V at pin 8 indicates that the oscillator signal is present.
4. To check the A-D signal at pin 1, you need an oscilloscope. You should see a change in the A-D signal as you change the light level. If not, yet IC1 and IC4 test properly, replace IC2.
5. Check the voltages at pins 12, 13, 14, and 15. The voltages should be either high (around 1.6V) or low (0V), depending on the setting of the shutter wiper. At the program setting, the voltage at pin 12 should be high. If the voltage at pin 12 is low, replace IC2.

IC3

Since IC3 is on the LED display board, you can't reach the pins for voltage tests. However, you can check input signals at the IC3 connecting wires on top of the flex. Or you can measure the pin voltages by first lifting aside the film-speed base plate and piezo beeper, Fig. 92. Jumper the ground land on the film-speed base plate to the camera body for the ground connection.

1. Check for the input E1 voltage at the red wire or to pin 9. No voltage—check the continuity between the red-wire connection and the collector of TR1.
2. Check for the input oscillator signal at the blue wire or at pin 6. Using an oscilloscope at the DC setting, you can determine if the oscillator signal rides on 0V or on a positive voltage. The clock signal should rise above 0V, Fig. 25. But if the clock signal rides on a positive voltage, replace IC3.
3. Check for the input signal at the purple wire or at pin 7 using an oscilloscope. The input signal should be the same as the output signal at pin 20 of IC2. If you get the input signal, but the LED display doesn't change, replace IC3. Note: For a defective IC3, replace the complete decoder/driver unit CY1-1078-000.

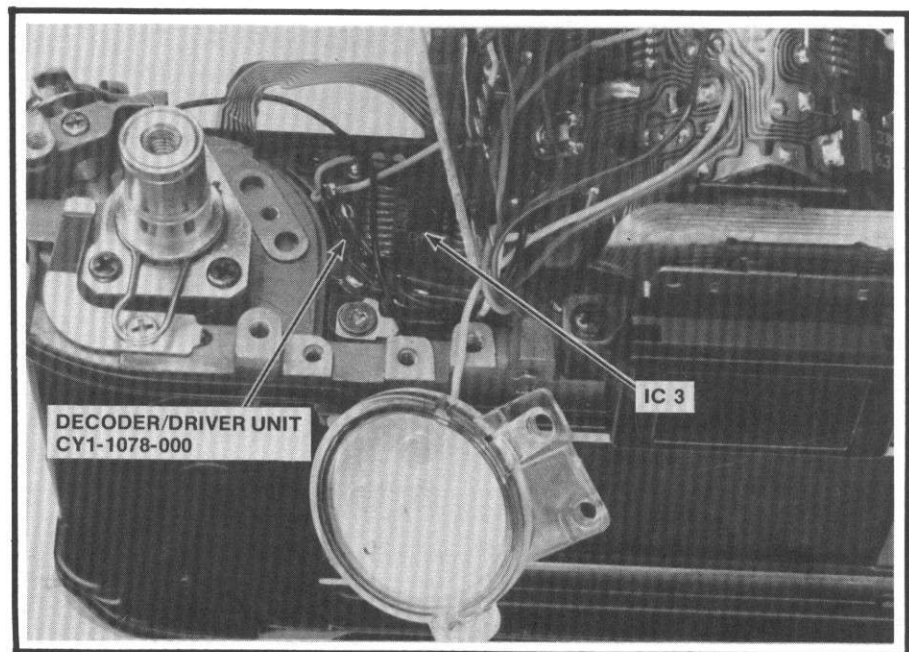

Figure 92

IC4

1. Check for the input E1 voltage at pin 6. No voltage—check for continuity between pin 6 and the collector of TR1.
2. Check for the Vc voltage at pin 7; you should measure 1.3V. No voltage—replace IC4.
3. Check the MOS output at pin 11. The voltage should go more positive as you increase the light striking the SPD. No change—replace IC4.
4. Check the AR5 output at pin 4. The voltage should go more positive as you increase the light striking the SPD. No change—replace IC4.
5. Check the AVO signal at pin 2. You should measure around 1.8V without a lens on the camera. When you push in the maximum-aperture correction pin, you should see the voltage decrease—around 1.5V with the maximum-aperture correction pin pushed completely in. No change—check the maximum-aperture resistor VR102 by measuring the resistance between the white wire, Fig. 91, and ground. The resistance should go from around 4K to around 11K as you push in the maximum-aperture correction pin. If the maximum-aperture resistor checks properly, but you don't get the voltage change at pin 2, replace IC4.

SECTION 16 — REPLACING THE IC'S

You can replace IC1, IC2, and IC4 without removing the flex circuit. Each IC fits into a rectangular cutout in the flex. The pins then solder directly to the flex lands.

To protect the flex during soldering, it's helpful to make a special tool like the one shown in Fig. 93. The tool is a piece of cardboard or fibre board with a rectangular cutout; the cutout clears the IC casing. In Fig. 93, the tool has several cutouts to fit the different IC's. The large cutout at the end fits IC2.

Just slip the tool under the flex, Fig. 94, with the cutout over the IC casing. As you unsolder the old IC, the tool protects the pentaprism cover from the heat of the soldering iron. The tool provides firm support for the flex when you mount the new IC.

With a slight variation on the tool, however, you can make IC removal easier. Cement a solid pad to one end of the tool, Fig. 95. Slip the tool under the flex with the pad at the bottom of the IC casing. As you then unsolder the IC pins, the tool tends to push up the IC.

To remove IC2, first disconnect the lead of resistor R11 from pin 6. Then move the resistor away from the IC, Fig. 94. With the special tool in place, flow solder over all the pins on one side of the IC. Next flow solder over all the pins on the other side of the IC, Fig. 96.

Now slowly move your soldering iron along the solder bridge on one side of the IC. If you're using the tool with the pad, you'll find that the entire side of the IC "floats" away from the flex as all 11 pins disconnect. Most of the excess solder you applied remains with the IC.

Repeat the procedure to disconnect the 11 pins at the other side of the IC. By using the solder bridges, you should not have to lift an IC pin from the flex. Lifting an IC pin with your tweezers may pull loose the flex solder pad.

Use a similar procedure to remove IC1. But here you can use a single solder bridge. Flow a complete ring of solder around the IC. The solder bridge should connect all the IC pins as well as the ground tabs at the ends of the IC.

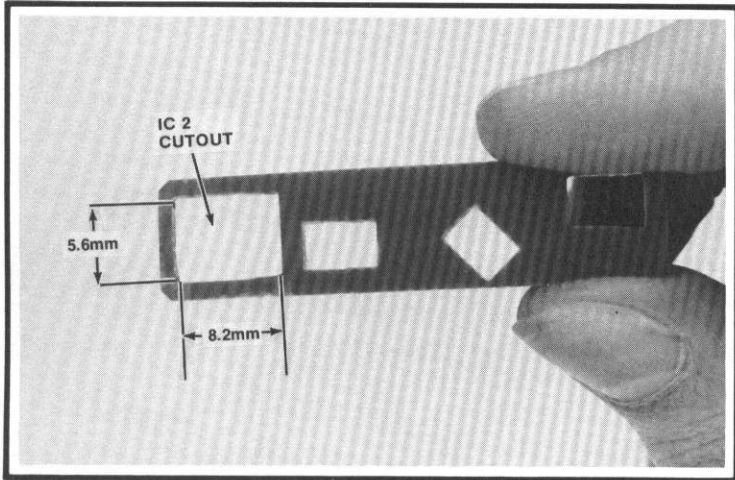

Figure 93

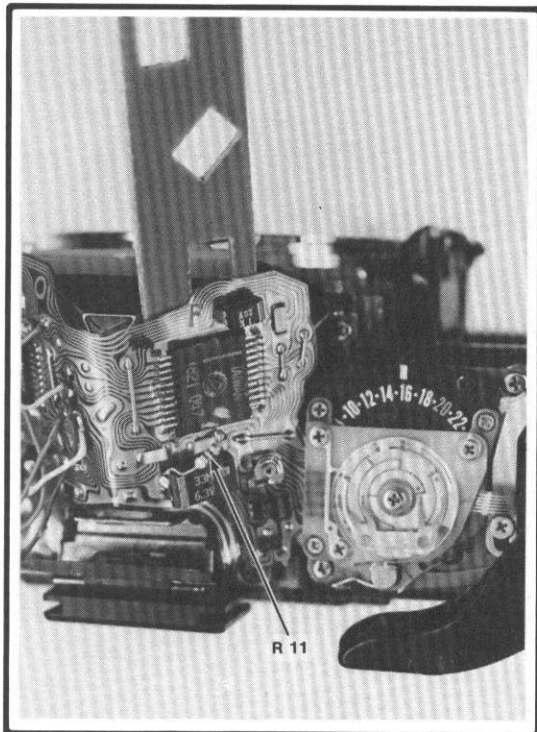

Figure 94

Now slowly walk your soldering iron around the solder ring. As the solder bridge liquifies, you'll find that the complete IC "floats" up and off the flex. The moment you see the IC float up, lift the IC off the flex circuit. Again, by using the solder bridge, you should not have to apply any lifting pressure to the IC.

Before you install the new IC, check for solder bridges on the flex pads. You may have to remove some of the solder from the flex using desoldering wick or a desoldering tool. It should not be necessary to apply any solder to the solder pads.

Now tin each of the pins of your replacement IC. Each pin should have a slight amount of solder for a good connection. Insert the tool with the rectangular cutout under the flex. Note the proper IC orientation and seat the new IC in its rectangular cutout.

Since the special tool clears the bottom of the IC casing, all the IC pins should come against their solder pads on the flex—you should not have to push down the IC to solder the pins. Make sure that each IC pin sits on top of its own solder pad.

Move your soldering iron along the pins on one side of the IC. There should already be enough solder on the pins and on the solder pads for good connections—you should not have to apply solder once you've mounted the IC. Applying solder after you've installed the IC runs the risk of a solder bridge between pins. However, you can safely apply additional solder to the ground tabs of IC1.

An IC can be damaged by applying heat for a long period of time. But you should not have to hold the soldering iron on one pin for very long. By slowly moving the soldering iron along the pins, you can melt the solder and prevent solder bridges. A 27-watt soldering iron should be all you need. But don't use a soldering iron of more than 47 watts. Applying excessive heat is more likely to damage the flex than the IC.

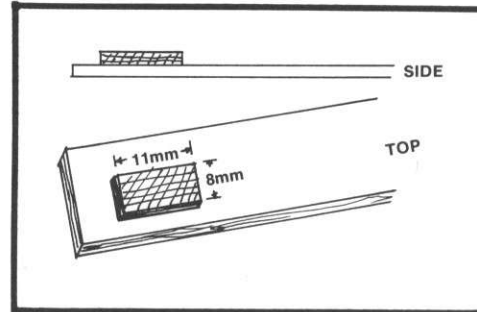

Figure 95 Pad dimensions for IC2

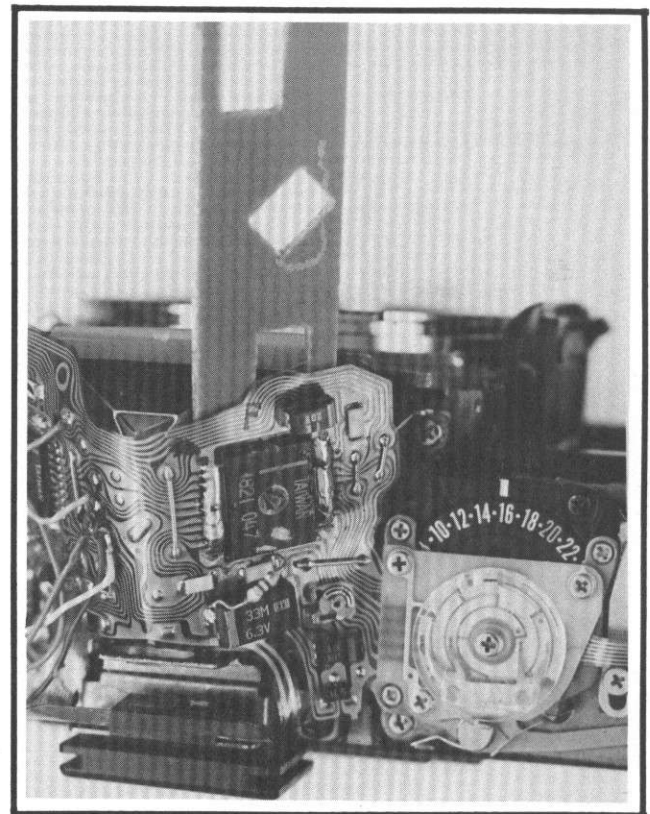
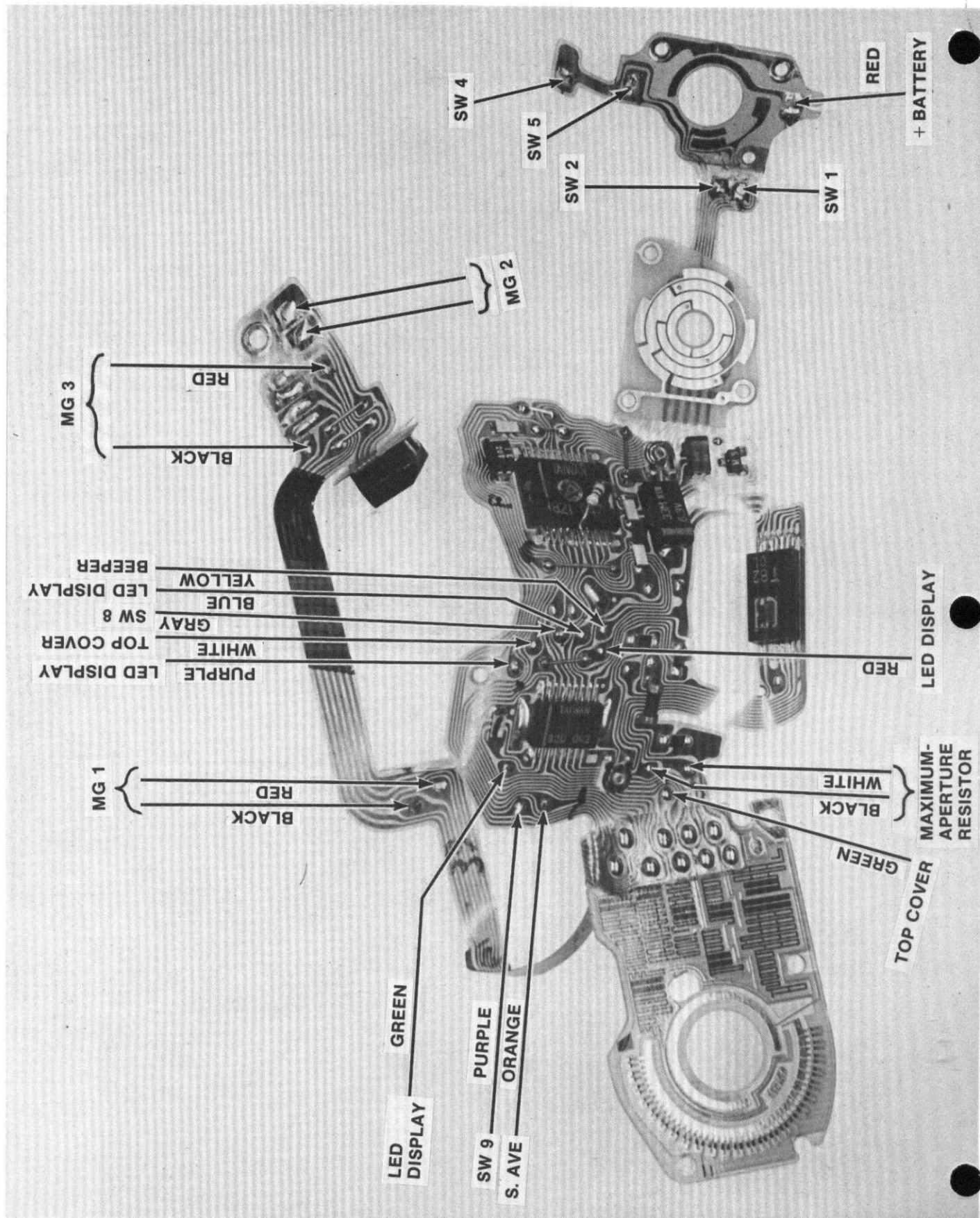
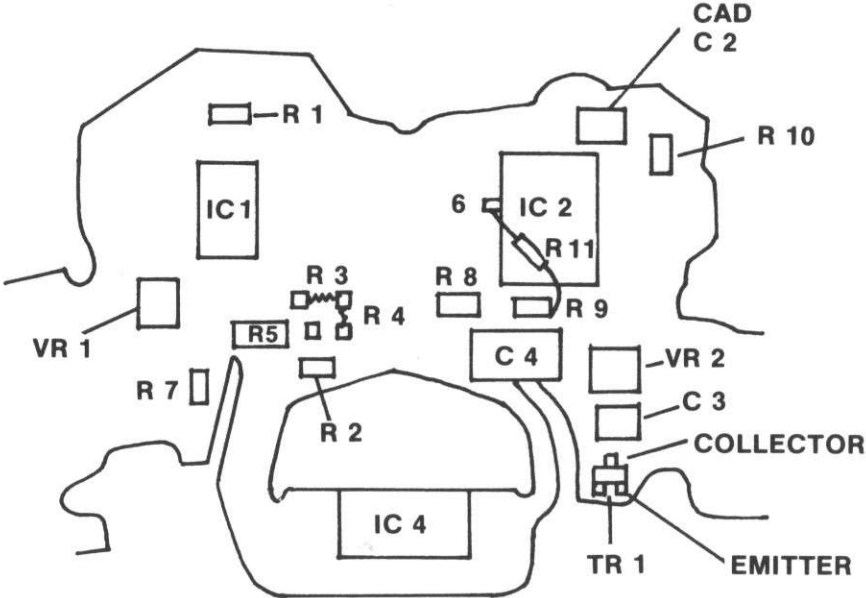

Figure 96

Section 17 — Supplements — Wiring, Flex Circuit



Component Identification, Flex Circuit



Wiring, LED display board

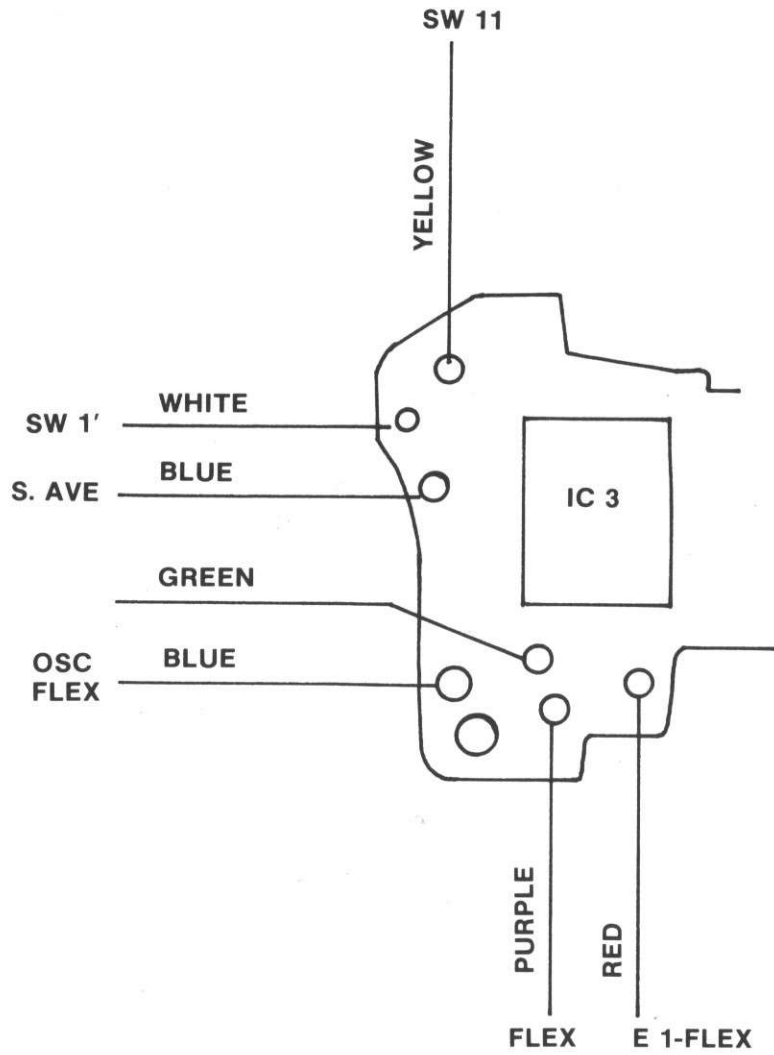

Pin Voltages, IC1

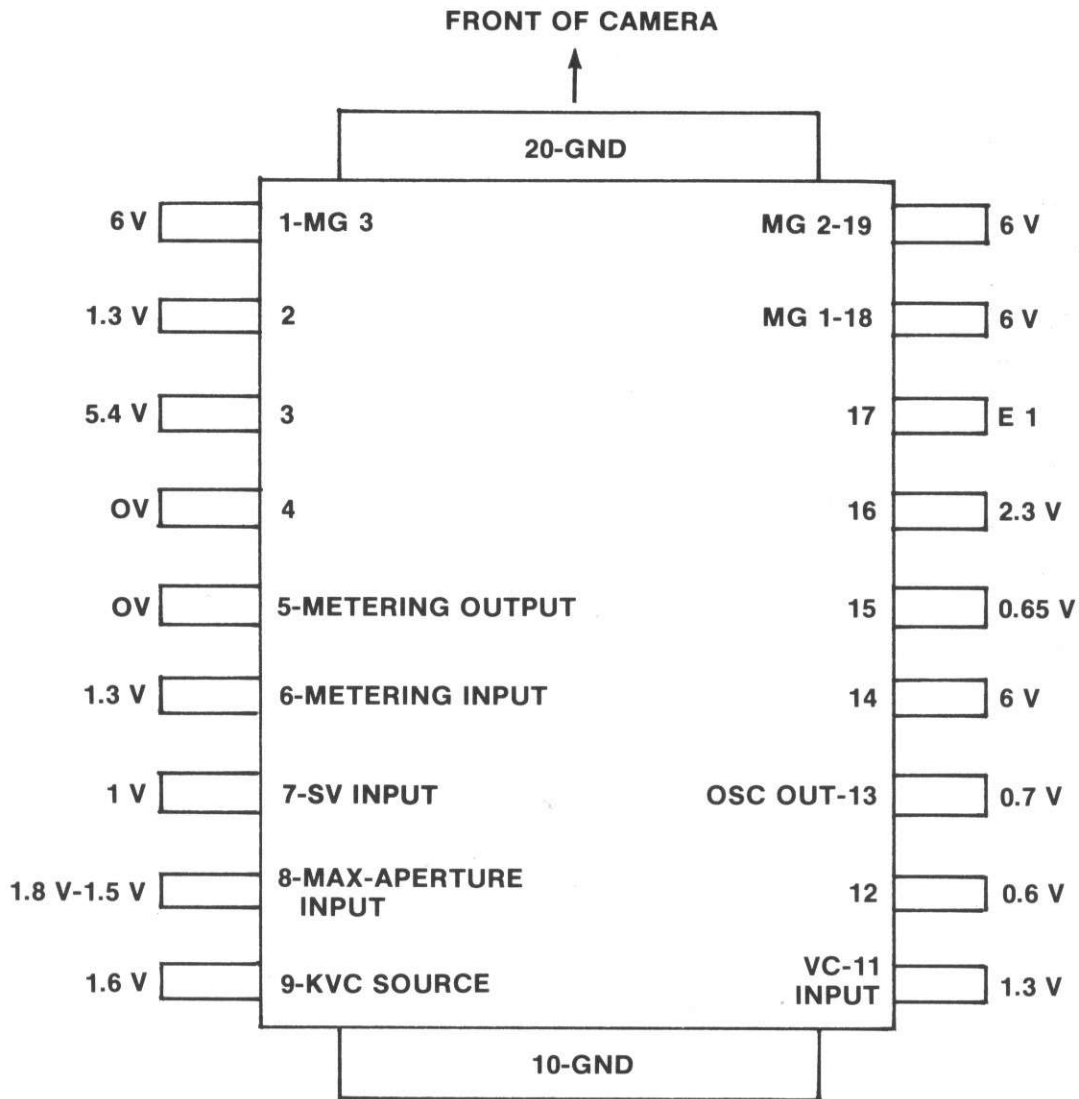

Pin Voltages, IC2

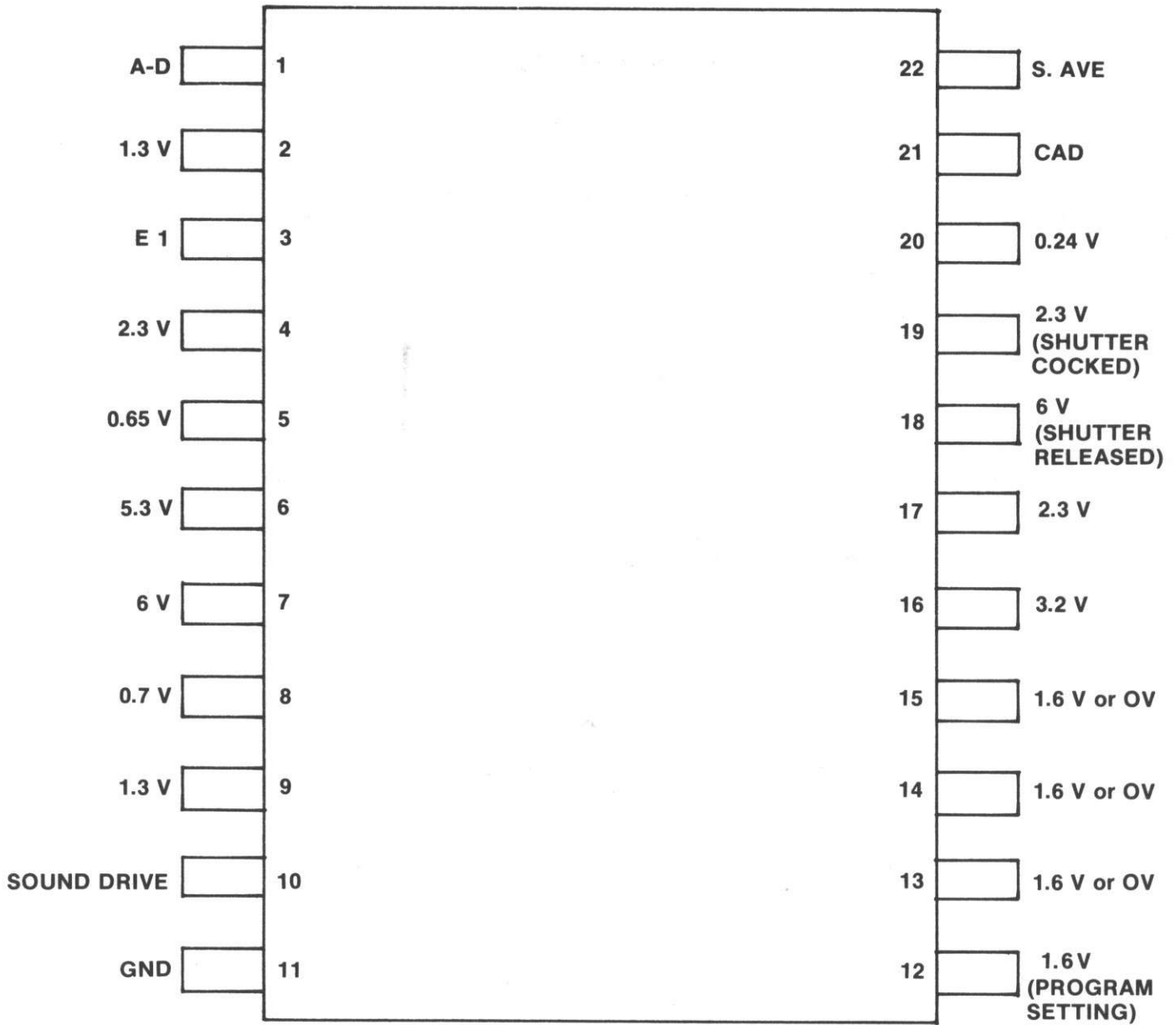

Pin Voltages, IC3

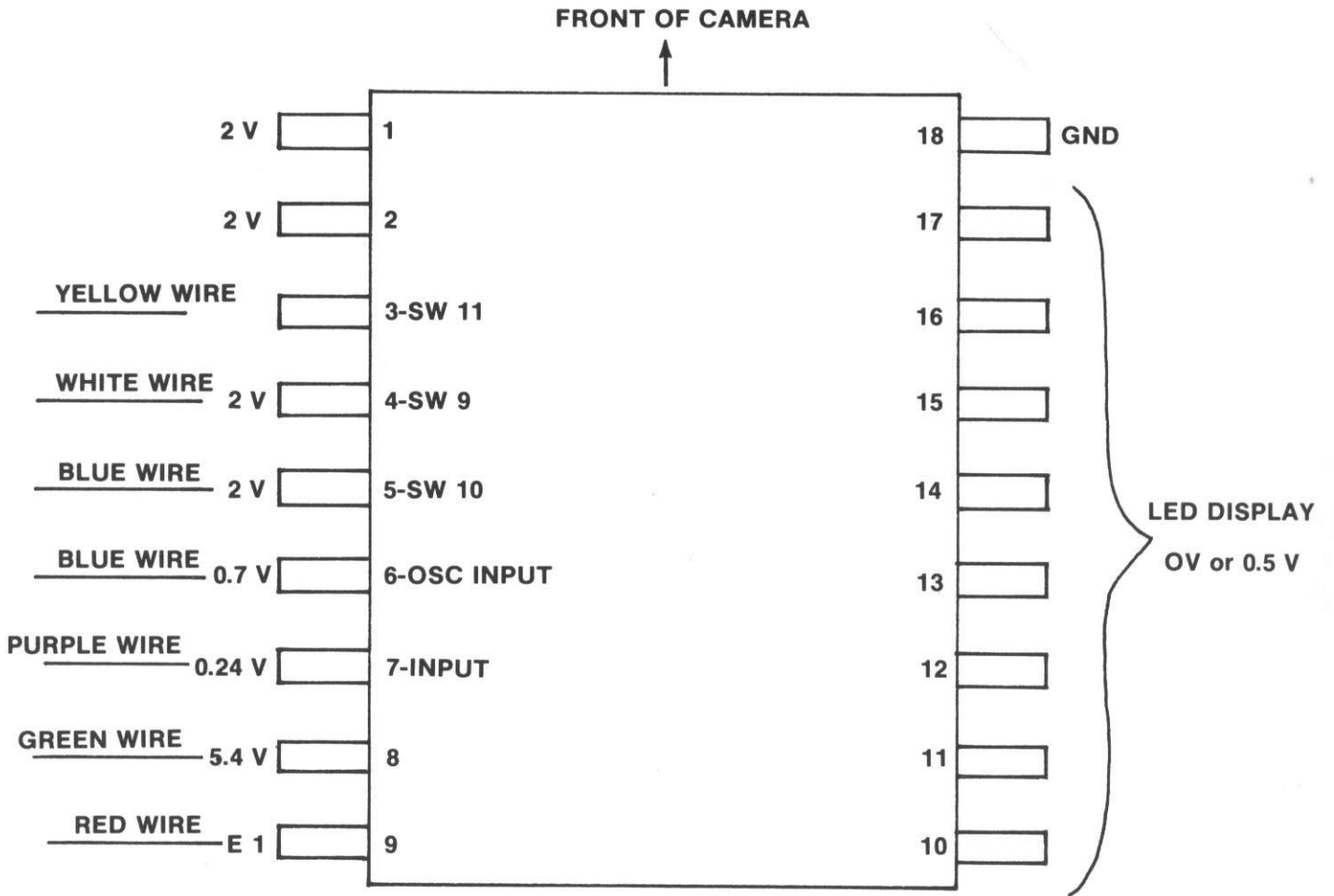

Pin Voltages, IC4

